

Port of Port Arthur Navigation District of Jefferson County, Texas

Contract Documents
for

Seafarer Center Parking Lot Expansion

April 2024

Commissioners:

John Comeaux, President
Randy T. Martin, Vice President
Linda Turner Spears, Secretary/Treasurer
Raymond Johnson, Commissioner
Mary Wycoff, Commissioner

Larry Kelley, Port Director / CEO

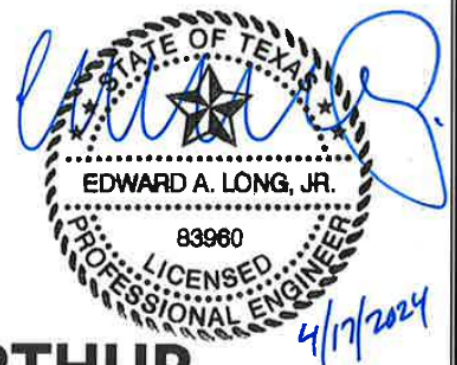

SECTION A
NOTICE TO BIDDERS

**PORT OF PORT ARTHUR NAVIGATION DISTRICT OF JEFFERSON COUNTY,
TEXAS NOTICE TO BIDDERS OF MANDATORY PRE-BID CONFERENCE**

NOTICE IS HEREBY GIVEN THAT A MANDATORY PRE-BID CONFERENCE will be held on Wednesday, May 1, 2024 at 2:00 p.m. at the Administration Building Conference Room of the Port of Port Arthur Navigation District of Jefferson County, Texas (“Port of Port Arthur”), located at 221 Houston Avenue, Port Arthur, Texas 77640, to discuss the Port of Port Arthur Seafarer Center Parking Lot Expansion Project (the “Project”), consisting of the furnishing of all materials, equipment, tools, labor, supervision services, and performing all operations in connection with the site preparation and expansion of existing parking facilities, and other related work. Registration for the Mandatory Pre-Bid Conference will begin onsite at 1:30 p.m. on May 1, 2024, and there will be no admission after 2:00 p.m.

Thereafter, sealed bids addressed to the Port of Port Arthur for the Project will be received at the office of the Port Director, Larry Kelley, 221 Houston Avenue, Port Arthur, Texas, 77640 until 9:00 a.m. local time on Wednesday, May 15, 2024, and all bids received will immediately thereafter be opened and publicly read. The bid shall be on original bid form as shown in the project specification and without any modification. Any bid received after closing time will be returned unopened.

A performance bond and payment bond, each in the amount of one hundred percent (100%) of the contract price, will be required in accordance with State Law for any contract more than Twenty-Five Thousand (\$25,000) Dollars. A Bid Bond in the amount of 5% of the total bid must also be submitted with the Bid documents.

Each bidder will be required to hold insurance naming the Port of Port Arthur as an additional insured and certificate holder under the policy(ies), with minimum coverages as set forth in the Insurance Requirements section of the specifications, found at its website, www.portpa.com. Additionally, plans, specifications, and/or drawings for the Project may also be found on the Port of Port Arthur’s website.

Attention is called to the fact that this is a contract for construction of public works and that there must be paid on same not less than the prevailing wage rates which have been established by all applicable statutes and the terms of this contract pursuant to State Law and which are set out in detail in the contract documents. The Contractor shall forfeit as a penalty to the Port of Port Arthur Ten (\$10.00) Dollars for each laborer, workman or mechanic employed, for each calendar day, or portion thereof, if such laborer, workman or mechanic is paid less than the said stipulated rates for any work done under this contract, by him, or by any subcontractor under him. A copy of such current wage schedule is included in the contract documents and any Equal Employment Opportunity requirements must be met.

The Port of Port Arthur is an organization which qualifies for exemptions pursuant to the Texas Tax Code, Chapter 151, Limited Sales, Excise and Use Tax Act. No Texas sales tax shall be included on the prices bid for tangible personal property which is to be incorporated into and/or consumed in the performance of this Project. The contractor performing this Project may purchase

materials, supplies, and/or equipment incorporated into and/or consumed in the performance of this Project by providing to its suppliers an exemption certificate issued in accordance with Texas law.

The Port of Port Arthur reserves the right to reject any, and all bids and waive any formalities.

For inspection of the existing facilities or bidding documents, contact Michael Green, Construction Coordinator, at 409-983-2011. Bidding documents are also available by contacting the Associated General Contractors of Southeast Texas or can be downloaded from www.portpa.com.

SECTION B
INSTRUCTION TO BIDDERS

INSTRUCTIONS TO BIDDERS

1. Defined Terms.

Terms used in these Instructions to Bidders have the meanings assigned to them in the General and Supplementary Conditions of the Contract Documents. The term "Bidder" means one who submits a Bid directly to Owner, as distinct from sub-bidder, who submits a bid to a Bidder. The term "Successful Bidder" means the lowest, qualified, responsible and responsive Bidder to whom Owner (on the basis of Owner's evaluation hereinafter provided) makes an award. The term "Bidding documents" includes the Advertisement or Invitation to Bid, Instructions to Bidders, the Bid Form, and the proposed Contract Documents (including all Addenda issued prior to receipt of Bids).

2. Copies of Bidding Documents.

- 2.1 Complete sets of the Bidding Documents, stated in the Notice to Bidders of Mandatory Pre-Bid Conference, may be obtained from the following locations:
 - 2.1.1 Download from the Port of Port Arthur website at www.portpa.com.
 - 2.1.1 Associated General Contractors of Southeast, Texas.
- 2.2 Complete sets of Bidding Documents must be used in preparing Bids; neither Owner, Engineer of Record, nor Owner's Representative assumes any responsibility for errors or misinterpretations resulting from the use of incomplete sets of Bidding Documents.
- 2.3 Owner and Owner's Representative in making copies of Bidding Documents available on the above terms do so only for the purpose of obtaining Bids on the Work and do not confer a license or grant for any other use.

3. Qualifications of Bidders.

To demonstrate qualifications to perform the Work, each Bidder must submit, with their Bid, evidence of Bidder's qualifications to do business in the State of Texas or covenant to obtain such qualifications prior to award of contract. Bidder shall be prepared to submit within five days of Owner's request the following written evidence:

- 3.1 Present list of project commitments and list of similar projects.
- 3.2 Other such data as may be reasonably requested by Owner.
- 3.3 Method of Award: The Port of Port Arthur Navigation District, upon receipt of all bids with review bids received and award the contract to the lowest, responsive, responsible bidder, that provides the best value for their services to the Port of Port Arthur Navigation District. This will be completed by a complete review of all required bid documents and other items listed above by Port of Port Arthur staff and Approval by our Board of Commissioners.

4. Examination of Contract Documents and Site.

- 4.1 It is the responsibility of each Bidder before submitting a Bid, to (a) examine the Contract Documents thoroughly, (b) visit the site to become familiar with local conditions that may affect cost, progress, performance and furnishing of the Work, (c) consider federal, state

and local Laws and Regulations that may affect cost, progress, performance or furnishing of the Work, (d) study and carefully correlate Bidder's observations with the Contract Documents, and (e) notify Owner's Representative of all conflicts, errors or discrepancies in the Contract Documents.

- 4.2 Reference is made to the Contract Documents for identification of:
- 4.2.1 Those drawings of physical conditions in or relating to existing surface and subsurface conditions (except Underground Facilities) which are at or contiguous to the site which have been utilized by Engineer of Record in preparation of the Contract Documents. Copies of such reports and drawings will be made available by the Owner to any Bidder on request.
- 4.3 Information and data reflected in the Contract Documents with respect to Underground Facilities at or contiguous to the site is based upon information and data furnished to Owner and Engineer of Record by owners of such Underground Facilities or others, and completeness thereof.
- 4.4 Provisions concerning responsibilities for the adequacy of data furnished to prospective Bidders on subsurface conditions, Underground Facilities and other physical conditions, and possible changes in the Contract Documents due to differing conditions appear in Paragraphs 5.03,5.04 and 5.05 of the General Conditions.
- 4.5 Before submitting a Bid, each Bidder will, at Bidder's expense, make or obtain any additional examinations, investigations, explorations, tests and studies and obtain any conditions (surface, subsurface and Underground Facilities) at or contiguous to the site or otherwise which may affect cost, progress, performance of furnishing of the Work and which Bidder deems necessary to determine its Bid for performing and furnishing the Work in accordance with the time, price and other terms and conditions of the Contract Documents.
- 4.6 On request in advance, the Owner will provide each Bidder with access to the site to conduct such explorations and tests as each Bidder deems necessary for submission of a Bid. The bidder shall fill all holes, clean up and restore the site to its former condition upon completion of such explorations.
- 4.7 The lands upon which the Work is to be performed, rights-of-way and easements for access thereto and other lands designated for use by Contractor in performing the Work are identified in the Contract Documents. All additional lands and access thereto required for temporary construction facilities or storage of materials and equipment are to be provided by Contractor. Easements for permanent structures permanent changes in existing structures are to be obtained and paid for by the Owner unless otherwise provided in the Contract Documents.
- 4.8 The submission of a Bid will constitute an incontrovertible representation by Bidder that Bidder has compiled with every requirement of this Article 4, that without exception the Bid is premised upon performing and furnishing the Work required by the Contract Documents and such means, methods, techniques, sequences or procedures of construction as may be indicated in or required by the Contract Documents, and that the Contract Documents are sufficient in scope and detail to indicate and convey understanding of all terms and conditions for performance and furnishing of the Work.

5. Interpretations and Addenda.

- 5.1 All questions about the meaning or intent of the Contract Documents are to be directed to the Owner's Representative. Interpretations or clarifications considered necessary by the Engineer of Record in response to such questions will be issued by Addenda mailed, emailed, or delivered to all parties recorded by Owner's Representative as having received the Bidding Documents. Questions received less than five (5) days prior to the date of opening of Bids may not be answered. Only questions answered by formal writing will be binding. Oral and other interpretations or clarifications will be without legal effect.
- 5.2 Addenda may also be issued to modify the Bidding Documents as deemed advisable by Owner or Owner's Representative.

6. Bid Security.

- 6.1 Each Bid must be accompanied by Bid security made payable to Owner in an amount of five percent (5%) of the Bidder's maximum Bid price and in the form of a certified or bank check or a Bid Bond issued by a surety meeting the requirements of Paragraph 6.01 of the General Conditions.
- 6.2 The Bid security of the Successful Bidder will be retained until such Bidder has executed the Agreement and furnished the required contract security, whereupon the Bid security will be returned. If the Successful Bidder fails to execute and deliver the Agreement and furnish the required contract security within fifteen days after the Notice of Award, Owner may annul the Notice of Award and the Bid security of that Bidder will be forfeited. The Bid security of other Bidders whom Owner believes to have a reasonable chance of receiving the award may be retained by Owner until the earlier of the seventh day after the Effective Date of the Agreement or the sixty-first (61st) day after the Bid opening, whereupon Bid security furnished by such Bidders will be returned. Bid security with Bids which are not competitive will be returned within seven days after the Bid opening.

7. Contract Time / Contract Adjustment.

- 7.1 The number of days within which, or the dates by which, the Work is to be completed and ready for final payment (the Contract Time) are set forth in the Bid Form and the Agreement.
- 7.2 Attention is directed to the requirement that each Bidder specify on their Bid Form the time in which Bidder will agree to complete the Work. The time required for completion of the work will be a consideration in the determination of the successful bidder.
- 7.3 Any adjustments to the contract whether it be additional days, adjusted scope or contract price adjustment must have approval of Architect/ Engineer, Owner and any other applicable parties related to the contract and must be done so by a written change order issued by the owner, or the owners designated representative.

8. Liquidated Damages.

Provisions for liquidated damages are set forth in the Agreement and have been established at \$500 per day for every calendar day beyond the Contract Time that the Work is not complete, according to the contract documents.

9. Substitute or "Approved Substitution" Items.

The Contract, if awarded, will on the basis of materials and equipment described in the Drawings or specified in the Specifications without consideration of possible substitute or "approved substitution" items. Whenever it is indicated in the Drawings or specified in the Specifications that a substitute or "approved substitution" item of material or equipment may be furnished or used by Contractor if acceptable to Owner's Representative, application for such acceptance will not be considered by Owner's Representative until after the Effective Date of the Agreement. The procedure for submission of any such application by Contractor and consideration by Owner's Representative is set forth in Paragraphs 7.06 of the General Conditions and may be supplemented in the General Requirements.

10. Subcontractors, Suppliers and Others.

If specifically requested on the Bid Form, the Contractor will be required to list all proposed subcontractors.

11. Bid Form.

- 11.1 The Bid Form, along with the required forms for the Bid Bond, Payment Bond and Performance Bond are included with the Bidding Documents; additional copies may be obtained from OWNER.
- 11.2 All blanks on the Bid Form must be completed in ink or by typewriter.
- 11.3 Bids by corporations must be executed in the corporate name by the president or a vice-president (or other corporate officer accompanied by evidence of authority to sign), and the corporate seal must be affixed and attested by the secretary or assistant secretary. The corporate address and state of incorporation must be shown below the signature.
- 11.4 Bids by partnerships must be executed in the partnership name and signed by a partner, whose title must appear under the signature and the official address of the partnership must be shown below the signature.
- 11.5 All names must be typed or printed below the signature.
- 11.6 The Bid shall contain an acknowledgement of receipt of all Addenda (the numbers of which must be filled in on the Bid Form).
- 11.7 The address and telephone number for communications regarding the Bid must be shown.

12. Submission of Bids.

Bids shall be submitted at the time and place indicated in the Advertisement of Invitation to Bid and shall be enclosed in an opaque sealed envelope, marked with the project title (and, if applicable, the designated portion of the Project for which the Bid is submitted) and name and address of the Bidder and accompanied by the Bid security and other required documents. If the Bid is sent through the mail or other delivery system, the sealed envelope shall be enclosed in a separate envelope with the notation "BID ENCLOSED" on the face of it.

Submission Format: Sealed bid documents to be assembled in a letter size fastener style folder, report style folder, or ½” binder and to have tabbed dividers per sections listed below. Please do not staple any of the documents.

- Section 1: Bid Form
- Section 2: Bid Bond
- Section 3: Required Forms
 - Conflict of Interest Questionnaire
 - Energy Companies Non-Boycott Certification
 - Firearm Entity/Trade Association- Anti-Discrimination Form
 - Israel – Non-Boycott Certification
 - Certification – No State Funds
- Section 4: Project Experience, Commitments, and Proposed Team

13. Modification and Withdrawal of Bids.

- 13.1 Bids may be modified or withdrawn by an appropriate document duly executed (in the manner that a Bid must be executed) and delivered to the place where the Bids are to be submitted at any time prior to the opening of Bids.
- 13.2 If, within twenty-four hours after Bids are opened, any Bidder files a duly signed, written notice with Owner and promptly thereafter demonstrates to the reasonable satisfaction of Owner that there was a material and substantial mistake in the preparation of its Bid, that Bidder may withdraw its Bid and the Bid security will be returned. Thereafter, that Bidder will be disqualified from further bidding on the Work to be provided under the Contract Documents.

14. Opening of Bids.

Bids will be opened and (unless obviously non-responsive) read aloud publicly. An abstract of the amounts of the base Bids and major alternates (if any) will be made available to Bidders after the opening the Bids.

15. Bids to Remain Subject to Acceptance.

All Bids will remain subject to acceptance for sixty (60) days after the day of the Bid opening, but Owner may in its sole discretion, release any Bid and return the Bid security prior to that date.

16. Award of Contract.

- 16.1 Owner reserves the right to reject any and all Bids, including without limitation, nonconforming, nonresponsive, unbalanced, or conditional Bids. Owner also reserves the right to reject the Bid of any bidder whom it finds, after reasonable inquiry and evaluation, to not be responsible. Owner further reserves the right to reject the Bid of any Bidder if Owner to make an award to that Bidder, whether because the Bid is not responsive, or the Bidder is unqualified or of doubtful financial ability or fails to meet any other pertinent standard or criteria established by Owner.
- 16.1.1 Discrepancies between the written unit price and the numerical unit price will be resolved in favor of the written unit price. In case of ambiguity or lack of clarity in stating the prices in the Bid, Owner reserves the right to consider the most advantageous bid thereof or to reject the bid.

- 16.1.2 Discrepancies in the multiplication of units of work and unit prices will be resolved in favor of the unit prices.
- 16.1.3 Discrepancies between the indicated sum of any column of figures and the correct sum thereof will be resolved in favor of the correct sum.
- 16.2 In evaluating Bids, Owner will consider the qualifications of the Bidders, and whether or not the Bids comply with the prescribed requirements, and such alternatives, unit prices, and any other data, as may be requested in the Bid Form or prior to the Notice of Award.
- 16.3 Owner reserves the right to waive all formalities and defects in the Bids and the bidding process not involving price, time of submittal, or changes in the Work and to negotiate contract terms with the Successful Bidder.
- 16.4 Once the responsiveness of the Bids is established, the Owner will evaluate the Bids based on the Base Bid alone or in any combination with any Alternate Bid Items that may be included on the Bid Form.

17. Contract Security.

- 17.1 If the Contract exceeds Twenty-Five Thousand Dollars (\$25,000.00), Performance and Payment Bonds shall be furnished on prescribed forms in the amount of one hundred percent (100%) of the Contract Price with a corporate surety duly authorized to do business in the State of Texas. Attorneys-in-fact who signs Bonds must file with each Bond a certified and effective dated copy of the Power of Attorney. Bonds must be issued and signed by a surety named in "Companies Holding Certificates of Authority as Acceptable Sureties on Federal Bonds and as Acceptable Reinsuring Companies" as published in Department Circular 570 (as amended and supplemented) by the Bureau of the Fiscal Service, U.S. Department of the Treasury.
- 17.2 Paragraph 6.01 of the General Conditions sets forth Owner's requirements as to Performance and Payment Bonds. When the Successful Bidder delivers the executed Agreement to Owner, it must be accompanied by the required Performance and Payment Bonds.

18. Insurance

Bidder shall refer to the Insurance Requirement section of the Contract Documents for the mandatory insurance required for this project.

19. Signing of Agreement.

When Owner gives Notice of Award to the Successful Bidder, it will be accompanied by the required number of unsigned counterparts of the Agreement with all other written Contract Documents attached. Within fifteen days thereafter Contractor shall sign and deliver the required number of counterparts of the Bonds. Within ten days thereafter Owner shall deliver one fully signed counterpart to Contractor. Each counterpart is to be accompanied by a complete set of the Drawings with appropriate identification.

20. Pre-bid Conference.

A mandatory pre-bid conference will be held at 2:00 p.m. on the 1st day of May 2024 at:

Port of Port Arthur Navigation District
221 Houston Avenue
Port Arthur, TX 77640

Registration for mandatory pre-bid conference will begin onsite at 1:30 p.m. local time on May 1st, 2024, and there will be no admission after 2:00 p.m. Representatives of Owner and Engineer of Record will be present to discuss the Project. Bidders are encouraged to attend and participate in the conference. There will be no addendums issued at the pre-bid conference. Any necessary addenda will be issued to all prospective Bidders of record as Owner's Engineer considers necessary in response to questions arising at the conference.

21. Prevailing Wages.

The Contractor will be required to pay prevailing wages as set forth in the Agreement and in accordance with the current Wage Decision which has been included in the Contract Documents.

22. Diversity in Contracting Program

The successful Bidder on this contract will, by execution of the Agreement, agrees to use its best efforts to implement the Port's Diversity in Contracting Program in connection with this Project. The Port's Policy directive on Diversity in Contracting has been provided to the Contractor as part of these Contract Documents and can also be found on the Port's website at www.portpa.com.

23. Sales and Use Taxes.

Port of Port Arthur Navigation District is an organization which qualifies for exemptions pursuant to the Texas Tax Code, Chapter 151, Limited Sales, Excise and Use Tax Act. No Texas sales tax shall be included on the prices bid for tangible personal property which is to be incorporated into and/or consumed in the performance of this Project. The contractor performing this Project may purchase materials, supplies, and/or equipment incorporated into and/or consumed in the performance of this Project by providing to its suppliers and exemption certificate issued in accordance with Texas law.

24. Retainage.

Ten percent (10%) of the amount of each Progress Payment shall be retained by the Owner until final completion and acceptance of the project in accordance with Article 4.2 of the Agreement.

25. Owner Furnished Contractor Installed Items.

None.

END OF DOCUMENT

SECTION C

BID FORM

BID FORM

TO: Port of Port Arthur
221 Houston Avenue
P. O. Box 1428
Port Arthur, Texas 77641

Proposal of _____
(hereinafter called "BIDDER"), organized and existing under the laws of the State of _____, doing business as a * _____ and acting by and through _____. To the Port of Port Arthur Navigation District of Jefferson County, Texas (hereinafter called "OWNER").

In compliance with your Notice to Bidders, BIDDER hereby proposes to perform all work for the construction of:

Seafarer Center Parking Lot Expansion

in accordance with the CONTRACT DOCUMENTS, within the time set forth therein, and at the prices stated below, and to enter into Contract for same within the time specified in CONTRACT DOCUMENTS.

By submission of this BID, each BIDDER certifies, and in the case of a joint BID, each party thereto certifies as to his own organization, that this BID has been arrived at independently, without consultation, communication, or agreement as to any matter relating to this BID with any other BIDDER or with any competitor.

Bidder hereby agrees to commence WORK under this contract on or before a date to be specified in the Notice to Proceed and to fully complete with the Seafarer Center Parking Lot Expansion within _____ consecutive calendar days. BIDDER further agrees to pay as liquidated damages, the sum of \$500.00 for each consecutive calendar day thereafter as provided in Article 4 of the General Conditions.

Enclosed is Bid Security as required.

BIDDER acknowledges receipt of the following ADDENDUM:

* Insert "a corporation," "a partnership," or "an individual", as applicable.

BIDDER agrees to perform all the work described in the Contract Documents for the following unit prices or lump sum:

ITEM NO.	APPROX. QTY.	UNIT	DESCRIPTION OF ITEM WITH UNIT BID PRICE WRITTEN IN WORDS	UNIT PRICE	TOTAL AMOUNT
1.	1	L.S.	Bonds and Insurance Complete. @ _____ Per Lump Sum	\$ _____	\$ _____
2.	1	L.S.	TREE REMOVAL - EXCAVATION - EARTHWORK @ _____ Per Lump Sum	\$ _____	\$ _____
3.	1	L.S.	CONCRETE (FORMWORK-REBAR-PLACE&FINISH) @ _____ Per Lump Sum	\$ _____	\$ _____
4.	1	L.S.	PARKING LOT STRIPING @ _____ Per Lump Sum	\$ _____	\$ _____
TOTAL AMOUNT BID				\$ _____	

(TOTAL AMOUNT BID WRITTEN IN WORDS)

BASE BID

Non-Consumable Material and Equipment\$ _____

Skill, Labor and Consumable Material & Equipment \$ _____

Total Amount Base Bid\$_____

The prices mentioned herein shall be full compensation for furnishing all materials, equipment, labor and all other expenses necessary to perform the work in accordance with these Specifications and Contract Documents.

Amounts are to be given in words and in numbers and the amount shown in words shall govern in the event a discrepancy occurs.

Potential Subcontractors & Vendors:

RESPECTFULLY SUBMITTED,

DATE

SIGNATURE

ADDRESS

PRINT (NAME)

CITY, STATE & ZIP
(SEAL – if BID is by a Corporation)

TITLE

ATTEST

CONTACT NUMBER AND EMAIL ADDRESS

SECTION D

BID BOND

BID BOND: Port of Port Arthur Seafarer Center Parking Lot Expansion Project

KNOW ALL BY THESE PRESENTS, that we, the undersigned, _____, as Principal, and _____, as Surety, are hereby held and firmly bound unto PORT OF PORT ARTHUR NAVIGATION DISTRICT OF JEFFERSON COUNTY, TEXAS as OWNER in the penal sum of _____ for the payment of which, well and truly to be made, we hereby jointly and severally bind ourselves, successors and assigns.

Signed, this ____ day of _____, _____. The Condition of the above obligation is such that whereas the Principal has submitted to PORT OF PORT ARTHUR NAVIGATION DISTRICT OF JEFFERSON COUNTY, TEXAS a certain BID, attached hereto and hereby made a part hereof to enter into a contract in writing, for the Port of Port Arthur Seafarer Center Parking Lot Expansion Project.

NOW, THEREFORE,

- (a) If said BID shall be rejected, or
- (b) If said BID shall be accepted and the Principal shall execute and deliver a contract in the Form of Contract attached hereto (properly complete in accordance with said BID) and shall furnish a BOND for his faithful performance of said contract, and for the payment of all persons performing labor or furnishing material in connection therewith, and shall in all other respects perform the agreement created by the acceptance of said BID,

then this obligation shall be void, otherwise the same shall remain in force and effect; it being expressly understood and agreed that the liability of the Surety for any and all claims hereunder shall, in no event, exceed the penal amount of this obligation as herein stated.

The Surety, for value received, hereby stipulates and agrees that the obligations of said Surety and its BOND shall be in no way impaired or affected by any extension of the time within which the OWNER may accept such BID; and said Surety does hereby waive notice of any such extension.

IN WITNESS WHEREOF, the Principal and the Surety have hereunto set their hands and seals, and such of them as are corporations have caused their corporate seals to be hereto affixed and these presents to be signed by their proper officers, the day and year first set forth above.

By: _____

By: _____

IMPORTANT -Surety companies executing BONDS must appear on the Treasury Department's most current list (Circular 570 as amended) and be authorized to transact business in Texas.

SECTION E

CONSTRUCTION CONTRACT / INSURANCE REQUIREMENTS

AGREEMENT

between

PORT OF PORT ARTHUR NAVIGATION DISTRICT
OF JEFFERSON COUNTY, TEXAS

(“OWNER”)

and

(“CONTRACTOR”)

**STANDARD FORM OF AGREEMENT
BETWEEN OWNER AND CONTRACTOR
ON THE BASIS OF A STIPULATED PRICE**

THIS AGREEMENT is dated as of the _____ day of _____, 2024 by and between the Port of Port Arthur Navigation District of Jefferson County, Texas (hereinafter called "OWNER") and _____ (hereinafter called "CONTRACTOR").

OWNER and CONTRACTOR, in consideration of the mutual covenants hereinafter set forth, agree as follows:

Article 1. WORK.

CONTRACTOR shall complete all Work as specified or indicated in the Contract Documents. The Work is generally described as follows:

- 1.1 The Work of this project comprises the Port of Port Arthur Seafarer Center Parking Lot Expansion Project (the "Project"), consisting of the furnishing of all materials, equipment, tools, labor, supervision services, and performing all operations in connection with the site preparation and expansion of existing parking facilities, and other related work, all as more fully described in the Contract Documents, including CONTRACTOR'S Bid dated _____, which is attached hereto as Exhibit 2 and incorporated by reference herein for all purposes.

Article 2. CONTRACT TIME.

- 2.1 The Work will be substantially completed within _____ (____) consecutive calendar days from the date when the Contract Time commences to run as provided in paragraph 4.01 of the General Conditions. OWNER desires the Work to start as soon as practical with prior agreement from CONTRACTOR; OWNER may direct CONTRACTOR to start work prior to or after the date specified in paragraph 4.02 of the General Conditions.
- 2.2 CONTRACTOR shall pay OWNER \$500.00 per day Liquidated Damages for every calendar day beyond the Contract Time that the Work is not complete, according to the Contract Documents.

Article 3. CONTRACT PRICE.

- 3.1 CONTRACTOR and any Subcontractors shall pay prevailing wages according to the Davis-Bacon Act (40 U.S.C. §§ 3141-3148) as supplemented by Department of Labor regulations at 29 C.F.R. part 5. CONTRACTOR shall maintain certified payroll records in accordance with same and shall submit same on a weekly basis to

OWNER on prescribed forms. Information related to the Davis Bacon Act and current Wage Determinations is included in the Contract Documents and can also be found at the following website:

www.dol.gov/whd/govcontracts/dbra.htm

- 3.2 OWNER shall pay CONTRACTOR for completion of the Work in accordance with the Contract Documents in current funds.

Article 4. PAYMENT PROCEDURES.

CONTRACTOR shall submit Applications for Payment in accordance with Article 15 of the General Conditions.

- 4.1 *Progress Payments.* OWNER shall make progress payments on account of the Contract Price on the basis of CONTRACTOR'S Applications for Payment, on or about fourteen (14) days following the next regularly scheduled Port of Port Arthur Board of Commissioners' Meeting after submission of invoices by CONTRACTOR during construction as provided below. All progress payments will be done on the basis of the progress of the Work measured by the schedule of values established in Article 15 of the General Conditions.
- 4.2 *Retainage.* OWNER shall retain 10% of all progress payments otherwise due and payable under the terms of this contract. Retainage shall be paid as a part of the Final Payment, as defined in these Contract Documents.
- 4.3 *Final Payment.* Upon final completion and acceptance of the Work in accordance with Article 15 of the General Conditions, OWNER shall pay the remainder of the Contract Price as recommended by OWNER'S REPRESENTATIVE and as provided in paragraph 15.06 of the General Conditions.
- 4.4 *Interest.* All monies not paid when due as provided in Article 15 of the General Conditions shall bear interest at the maximum rate allowed by law. Retainage shall not be considered due until Final Payment is due, and shall not bear interest until Final Payment is due.
- 4.5 *Affidavits Regarding Title.* OWNER may require CONTRACTOR to sign an affidavit attesting to CONTRACTOR'S title to work covered by each payment according to Article 15 of the General Conditions.

Article 5. INSURANCE AND INDEMNIFICATION.

- 5.1 At all times during the performance of this Agreement, CONTRACTOR will, at its own expense, and CONTRACTOR'S subcontractors will, at their own or at CONTRACTOR'S expense, carry the insurance coverage as detailed on Exhibit 1, Contractor Insurance Requirements, which is attached hereto and incorporated by reference herein for all purposes. CONTRACTOR will, at its own expense, furnish to OWNER certificates attesting to the fact that such policies are in effect. All insurance shall be issued by an insurance company authorized to do business in the State of Texas. OWNER shall be additional insured on all policies, excluding Worker's Compensation/Employer's Liability. Insurance shall be made on an "occurrence form" rather than a "claims made form" except Professional Liability may be provided on a "claims made" basis provided the retroactive date is prior to the effective date of this Agreement.
- 5.2 Insurance certificates evidencing the required coverages of CONTRACTOR and its subcontractors and endorsements evidencing the naming of OWNER as additional insured shall be delivered to OWNER prior to commencement of the Work under this Agreement. The CONTRACTOR agrees that it will not cancel, reduce, restrict, or materially change any policy providing coverage for Work under this Agreement until Final Completion and acceptance by OWNER. Each policy of insurance required shall provide for advance notice to the OWNER prior to cancellation in accordance with policy terms and conditions as governed by applicable law. If the insurer does not notify the OWNER upon policy cancellation, it shall be the CONTRACTOR'S responsibility to notify the OWNER of such cancellation. CONTRACTOR shall be responsible for procuring immediate replacement coverage for any such cancelled insurance. The OWNER'S failure to respond to any deficient insurance certificate received by the OWNER shall not constitute a waiver of the OWNER'S rights, or the CONTRACTOR'S insuring obligations, under this Agreement. OWNER shall be provided complete policies of insurance providing coverage for Work under this Agreement from CONTRACTOR upon written request.
- 5.3 Any and all deductibles in the above described insurance policies shall be assumed by, for the account of, and at CONTRACTOR'S sole risk.
- 5.4 Each policy shall be endorsed to provide waiver of subrogation rights in favor of OWNER, its subsidiaries and affiliates and all other parties owning an interest in the property on which Work covered by this Agreement is to be performed. CONTRACTOR agrees to waive and agrees to have its insurer waive any rights of subrogation as respects deductibles under such policies and as respects damages to equipment, including the loss of use thereof, whether insured or not.

- 5.5 Failure of CONTRACTOR to keep the required insurance policies in full force and effect hereunder shall constitute a breach of this Agreement and OWNER shall have the right, in addition to any other rights, to immediately cancel and terminate this Agreement.
- 5.6 Nothing contained in these provisions relating to coverage and amounts set out herein shall operate as a limitation of CONTRACTOR'S liability in tort or contracted for under the terms of this Agreement.
- 5.7 CONTRACTOR will not be responsible for any pre-existing materials containing substances classified as hazardous, potentially hazardous, infectious, toxic or dangerous under applicable law, including but not limited to materials containing the substance asbestos, and such materials will be disposed of in strict compliance with all regulations as directed by OWNER and/or OWNER'S REPRESENTATIVE. Should CONTRACTOR, during the course of the Work, encounter site materials that it believes may be hazardous, potentially hazardous, infectious, toxic or dangerous, it shall immediately notify OWNER or OWNER'S REPRESENTATIVE. OWNER will retain title to all hazardous waste presently on site encountered during demolition, removal, and excavation. This does not include hazardous materials generated by CONTRACTOR, such as used motor oils, lubricants, cleaners, etc. CONTRACTOR shall dispose of such hazardous waste according to the Contract documents, following local, State, and Federal regulations.
- 5.8 CONTRACTOR shall also file with the OWNER valid Certificates of Insurance with endorsements on like form for all consultants or subcontractors. Similar insurance shall be provided by or on behalf of all consultants or subcontractors to cover their operations under the Agreement. In the event a consultant or subcontractor is unable to furnish insurance as required under the Contract, then the available insurance limits and coverages may be reviewed by the OWNER and insurance requirements may be amended. Such review and amendment will not be unreasonably withheld.
- 5.9 CONTRACTOR shall promptly report to OWNER all accidents occurring to CONTRACTOR employees or any other parties or property.
- 5.10 NOTWITHSTANDING ANYTHING IN THE CONTRACT DOCUMENTS TO THE CONTRARY, the Work to be performed under this Agreement will be performed entirely at CONTRACTOR'S risk, and CONTRACTOR assumes all responsibility therefor.
- 5.11 NOTWITHSTANDING ANYTHING IN THE CONTRACT DOCUMENTS TO THE CONTRARY, THE CONTRACTOR SHALL INDEMNIFY AND HOLD HARMLESS THE OWNER AND ALL OF ITS AGENTS, OFFICERS, COMMISSIONERS AND EMPLOYEES, FROM AND AGAINST ALL CLAIMS, DAMAGES, LOSSES AND EXPENSES, INCLUDING ATTORNEY'S FEES,

ARISING OUT OF OR RESULTING FROM THE PERFORMANCE OF THE WORK AND SERVICES HEREUNDER, WHETHER CAUSED IN PART BY THE NEGLIGENCE OF THE OWNER. IN ANY AND ALL CLAIMS AGAINST THE OWNER AND/OR CONTRACTOR, OR ANY OF THEIR AGENTS, OFFICERS, COMMISSIONERS AND EMPLOYEES, BY ANY EMPLOYEE, SUBCONTRACTOR, OR EMPLOYEE OF A SUBCONTRACTOR, OF THE CONTRACTOR, OR BY ANYONE DIRECTLY OR INDIRECTLY EMPLOYED BY CONTRACTOR OR ANYONE FOR WHOSE ACTS CONTRACTOR MAY BE LIABLE, THE INDEMNIFICATION OBLIGATION UNDER THIS PARAGRAPH SHALL NOT BE LIMITED IN ANY WAY BY ANY LIMITATION ON THE AMOUNT OR TYPE OF DAMAGES, COMPENSATION, OR BENEFITS PAYABLE BY OR FOR THE CONTRACTOR UNDER WORKERS' COMPENSATION ACTS, DISABILITY BENEFIT ACTS, OR OTHER EMPLOYEE BENEFIT ACTS. THIS CLAUSE IS NOT INTENDED TO INDEMNIFY THE OWNER FOR CLAIMS, DAMAGES, LOSSES, AND EXPENSES CAUSED BY THE SOLE NEGLIGENCE OF THE OWNER.

Article 6. CONTRACTOR'S REPRESENTATIONS.

In order to induce OWNER to enter into this Agreement CONTRACTOR makes the following representations:

- 6.1 CONTRACTOR has familiarized itself with the nature and extent of the Contract Documents, Work, site locality, and all local conditions and all Laws and Regulations that in any manner may affect cost, progress, performance or furnishing of Work.
- 6.2 CONTRACTOR has studied carefully all reports of explorations and tests of subsurface conditions and drawings of physical conditions which are identified in these Contract Documents and the technical data contained in such reports and drawings, upon which CONTRACTOR is entitled to rely.
- 6.3 CONTRACTOR has reviewed and checked all information and data shown or indicated on the Contract Documents with respect to existing Underground Facilities at or contiguous to the site and assumes responsibility for the site and assumes responsibility for the accurate location of said Underground Facilities. No additional examinations, investigations, expirations, tests, reports, studies or similar information or data in respect of said Underground Facilities are or will be required by CONTRACTOR in order to perform and furnish the Work at the Contract Price, within the Contract Time and in accordance with other terms and conditions of the Contract Documents, including specifically the provisions of paragraph 5.03 of the General Conditions.

- 6.4 CONTRACTOR has correlated the results of all such observations, examinations, investigations, explorations, tests, reports and studies with the terms and conditions of the Contract Documents.
- 6.5 CONTRACTOR has given OWNER and OWNER'S REPRESENTATIVE written notice of all conflicts, errors, or discrepancies that CONTRACTOR has discovered in the Contract Documents and the written resolution thereof by OWNER and OWNER'S REPRESENTATIVE is acceptable to CONTRACTOR.

Article 7. CONTRACT DOCUMENTS.

The Contract Documents which comprise the entire agreement between OWNER and CONTRACTOR concerning the Work consist of the following:

- 7.1 This Agreement (pages 1 to __, inclusive).
- 7.2 Contractor Insurance Requirements, attached hereto as Exhibit 1.
- 7.3 CONTRACTOR's accepted Bid and Bid Bond required by these Contract Documents, attached hereto as Exhibit 2.
- 7.4 Performance bond and payment bond, each in the amount of one hundred percent (100%) of the contract price, attached hereto as Exhibit 3.
- 7.5 Standard General Conditions and Supplementary Conditions of the Construction Contract.
- 7.6 Construction Specifications manual entitled _____ for Port of Port Arthur Seafarer Center Parking Lot Expansion Project, dated _____ (consisting of ____ pages).
- 7.7 Notice to Bidders of Mandatory Pre-Bid Conference.
- 7.8 Addenda, if any.
- 7.9 Notice to Proceed.
- 7.10 All certifications required by law or this Contract, attached hereto as Exhibit 4.
- 7.11 The following which may be delivered or issued after the Effective Date of the Agreement and are not attached hereto: All Written Amendments and other documents amending, modifying, or supplementing the Contract Documents pursuant to Article 11 of the General Conditions.

There are no Contract Documents other than those listed above in this Article 7. The Contract Documents may only be amended, modified or supplemented as provided in Article 11 of the General Conditions.

Article 8. TERMINATION.

The obligation to provide further services under this Agreement may be terminated:

- 8.1 *For cause*, by either party upon thirty days' written notice in the event of substantial failure by the other party to perform in accordance with the terms hereof through no fault of the terminating party. Notwithstanding the foregoing, this Agreement will not terminate as a result of such substantial failure if the party receiving such notice begins, within five days of receipt of such notice, to correct its failure to perform and proceeds diligently to cure such failure within no more than thirty days of receipt thereof; provided, however, that if and to the extent such substantial failure cannot be reasonably cured within such thirty day period, and if such party has diligently attempted to cure the same and thereafter continues diligently to cure the same, then the cure period provided from herein shall extend up to, but in no case more than, sixty days after the date of receipt of the notice.
- 8.2 *For convenience*, by OWNER effective upon the receipt of notice by CONTRACTOR.

Article 9. DISPUTE RESOLUTION.

- 9.1 OWNER and CONTRACTOR agree to negotiate in good faith upon receipt of any notice of a dispute between them prior to exercising their rights under this Agreement or under applicable law.
- 9.2 OWNER and CONTRACTOR agree that they shall first submit any and all unsettled claims, counterclaims, disputes, and other matters in question between them arising out of or relating to this Agreement or the breach thereof ("disputes"), to mediation.
- 9.3 This Agreement is to be governed by the laws of the State of Texas. Venue of any action arising out of or in any manner connected with this Agreement shall be in a State District Court of Jefferson County, Texas.

Article 10. APPLICABLE LAWS AND REGULATIONS.

- 10.1 CONTRACTOR shall comply with all federal, state, and local laws, statutes, ordinances, rules and regulations, and the orders and decrees of any courts or administrative bodies or tribunals in any manner affecting the performance of this Agreement, including without limitation workers' compensation laws, minimum and maximum salary and wage statutes and regulations, nondiscrimination laws and

regulations, licensing laws, and regulations. When required, CONTRACTOR shall furnish OWNER with satisfactory proof of this compliance.

Article 11. MISCELLANEOUS.

- 11.1 Terms used in this Agreement which are defined in Article 1 of the General Conditions will have the meanings indicated in the General Conditions.
- 11.2 No assignment by a party hereto of any rights under or interest in the Contract Documents will be binding on another party hereto without the written consent of the party sought to be bound; and specifically but without limitation moneys that may become due and moneys that are due may not be assigned without such consent (except to the extent that the effect of this restriction may be limited by law), and unless specifically stated to the contrary in any written consent to an assignment no assignment will release or discharge the assignor from any duty or responsibility under the Contract Documents.
- 11.3 OWNER and CONTRACTOR each binds itself, its partners, successors, assigns and legal representatives to the other party hereto, its partners, successors, assigns and legal representative in respect of all covenants, agreements and obligations contained in the Contract Documents.
- 11.4 A waiver of either party hereto of a breach of any provision of this Agreement shall not operate or be construed as a waiver of any subsequent breach by any party.
- 11.5 This instrument and the Contract Documents identified in Article 7 contain the entire agreement of the parties hereto and may not be changed except by written agreement duly executed by the parties hereto.
- 11.6 All agreements and covenants contained herein are severable, and in the event any clause or provision contained herein is declared to be invalid or unenforceable by any court of competent jurisdiction, this Agreement shall be interpreted as if such invalid or unenforceable agreements or covenants were not contained herein.
- 11.7 This Agreement shall inure to the benefit of, and be binding upon, the respective parties hereto and their respective successors, heirs and personal representatives; provided, however, that this Agreement may not be assigned by any party hereto without the prior written consent of the other parties hereto; the parties acknowledge and agree that the services of CONTRACTOR to be provided hereunder are based upon the unique personal qualifications and abilities of such CONTRACTOR.

IN WITNESS WHEREOF, OWNER and CONTRACTOR have signed this Agreement in triplicate. One counterpart each has been delivered to OWNER and CONTRACTOR. All portions of the Contract Documents have been signed or identified by OWNER and CONTRACTOR.

This Agreement is effective as of the date above written.

OWNER Port of Port Arthur
 Navigation District of
 Jefferson County, Texas

CONTRACTOR _____

By: _____

By: _____

Address for giving notices:

221 Houston Avenue
Post Office Box 1428
Port Arthur, Texas 77641

Address for giving notices:

License No. _____

Port of Port

I. INSURANCE REQUIREMENTS FOR CONSTRUCTION CONTRACTS

Contractor shall procure and maintain for the duration of the contract, *and for 2 years thereafter*, insurance against claims for injuries to persons or damages to property which may arise from or in connection with the performance of the work hereunder by the Contractor, his agents, representatives, employees, or subcontractors.

II. MINIMUM SCOPE AND LIMIT OF INSURANCE

Coverage shall be at least as broad as:

1. **Commercial General Liability (CGL):** Insurance Services Office (ISO) Form CG 00 01 covering CGL on an “occurrence” basis, including products and completed operations, property damage, bodily injury and personal & advertising injury with limits no less than **\$1,000,000** per occurrence. If a general aggregate limit applies, either the general aggregate limit shall apply separately to this project/location (ISO CG 25 03 or 25 04) or the general aggregate limit shall be twice the required occurrence limit.
2. **Automobile Liability:** Insurance Services Office Form CA 0001 covering Code 1 (any auto), with limits no less than **\$1,000,000** per accident for bodily injury and property damage.
3. **Workers’ Compensation:** Insurance as required by the State of Texas with Statutory Limits including United States Longshoreman & Harborworkers coverage, as may be required. Employers’ Liability insurance with a limit of no less than **\$1,000,000** per accident for bodily injury or disease.
4. **Umbrella/Excess Liabilities:** The Contractor shall provide Umbrella/Excess Liability insurance limits of at least the following:
 - a. For contract amount under \$5,000,000; At least \$5,000,000 limit
 - b. For contract amount from \$5,000,000 to \$25,000,000; At least \$10,000,000 limit
 - c. For contract amount from over \$25,000,000 to \$50,000,000; At least \$50,000,000 limit
 - d. For contract amount over \$50,000,000; At least \$50,000,000 limit
5. **Builder’s Risk:** (Course of Construction) insurance utilizing an “All Risk” (Special Perils) coverage form, with limits equal to the completed value of the project and no coinsurance penalty provisions.
6. **Surety Bonds:** as required and described below.
7. **Professional Liability:** (If Design/Build), with limits no less than **\$2,000,000** per occurrence or claim, and **\$2,000,000** policy aggregate.
8. **Contractors’ Pollution Legal Liability:** and/or Asbestos Legal Liability and/or Errors and Omissions (if project involves environmental hazards) with limits no less than **\$1,000,000** per occurrence or claim, and **\$2,000,000** policy aggregate.

If the Contractor maintains broader coverage and/or higher limits than the minimums shown above, the Entity requires and shall be entitled to the broader coverage and/or the higher limits

Port of Port Arthur

maintained by the Contractor. Any available insurance proceeds in excess of the specified minimum limits of insurance and coverage shall be available to the Entity.

Self-Insured Retentions

Self-insured retentions must be declared to and approved by the Entity. At the option of the Entity, either: the Contractor shall cause the insurer to reduce or eliminate such self-insured retentions as respects the Entity, its officers, officials, employees, and volunteers; or the Contractor shall provide a financial guarantee satisfactory to the Entity guaranteeing payment of losses and related investigations, claim administration, and defense expenses. The policy language shall provide, or be endorsed to provide, that the self-insured retention may be satisfied by either the named insured or Entity.

III. OTHER INSURANCE PROVISIONS

The insurance policies are to contain, or be endorsed to contain, the following provisions:

1. **The Entity, its officers, officials, employees, and volunteers are to be covered as additional insureds** on the CGL policy with respect to liability arising out of work or operations performed by or on behalf of the Contractor including materials, parts, or equipment furnished in connection with such work or operations and automobiles owned, leased, hired, or borrowed by or on behalf of the Contractor. General Liability coverage can be provided in the form of an endorsement to the Contractor's insurance (at least as broad as ISO Form CG 20 10, CG 11 85 or **both** CG 20 10, CG 20 26, CG 20 33, or CG 20 38; **and** CG 20 37 forms if later revisions used).
2. For any claims related to this project, the **Contractor's insurance coverage shall be primary** insurance coverage at least as broad as ISO CG 20 01 04 12 as respects the Entity, its officers, officials, employees, and volunteers. Any insurance or self-insurance maintained by the Entity, its officers, officials, employees, or volunteers shall be excess of the Contractor's insurance and shall not contribute with it.
3. Each insurance policy required by this clause shall provide that coverage shall not be canceled, except with notice to the Entity.

Special Circumstances

4. **Owner's & Contractors Protective Liability:** Primary contractors employing sub-contractors shall purchase and maintain at its own expense, Owner's & Contractor's Protective Liability coverage naming the Port, its officers, agents, and employees as insured in the same amount and coverage as provided for in the Contractor's Commercial General Liability Policy.
5. **Marine Operations:** If any operation involves the use of any form of watercraft, additional coverage may be required of Contractors as follows:
 - a. In the event the User is required to provide coverage pursuant to this section, such insurance on waterborne vessels shall comply with the following requirements:

Port of Port Arthur

- i. If the User uses a chartered waterborne vessel in the operation hereunder, the User shall provide Certificates of Insurance evidencing that the User has procured Charter's Legal Liability Insurance, including full Maritime Employers Liability and Collision and Tower's Liability, covering bodily injury and property damage with a combined single limit of at least \$1,000,000 or the value of the vessel, whichever is greater.
- ii. If the User uses an owned waterborne vessel in the operations hereunder, the User shall provide Certificates of Insurance evidencing that the User has procured Hull and Machinery Insurance, including full Collision and Tower's Liability and protection and Indemnity Insurance (including crew) covering bodily injury and property damage, each with a combined single limit of at least \$1,000,000 or the value of the vessel, whichever is greater.
- iii. The Port of Port Arthur will be named additional insured and right of subrogation will be waived in favor of the Port of Port Arthur by endorsement acceptable to the Port of Port Arthur risk manager.

Claims Made Policies-

If any coverage required is written on a claims-made coverage form:

1. The retroactive date must be shown, and this date must be before the execution date of the contract or the beginning of contract work,
2. Insurance must be maintained and evidence of insurance must be provided for at least five (5) years after completion of contract work.
3. If coverage is cancelled or non-renewed, and not replaced with another claims-made policy form with a retroactive date prior to the contract effective, or start of work date, the Contractor must purchase extended reporting period coverage for a minimum of five (5) years after completion of Contractor work.
4. A copy of the claims reporting requirements must be submitted to the Entity for review.
5. If the services involve lead-based paint or asbestos identification/remediation, the Contractor's Pollution Liability policy shall not contain lead-based paint or asbestos exclusion. If the services involve mold identification/remediation, the Contractor's Pollution Liability policy shall not contain a mold exclusion, and the definition of Pollution shall include microbial matter, including mold.

Acceptability of Insurers:

Insurance is to be placed with insurers authorized to conduct business in the state with a current A.M. Best rating of no less than A:VII, unless otherwise acceptable to the Entity.

Waiver of Subrogation:

Contractor hereby agrees to waive rights of subrogation which any insurer of Contractor may acquire from Contractor by virtue of the payment of any loss. Contractor agrees to obtain any

Port of Port Arthur

endorsement that may be necessary to affect this waiver of subrogation. **The Workers' Compensation policy shall be endorsed with a waiver of subrogation** in favor of the Entity for all work performed by the Contractor, its employees, agents, and subcontractors.

Verification of Coverage

Contractor shall furnish the Entity with original Certificates of Insurance including all required amendatory endorsements (or copies of the applicable policy language effecting coverage required by this clause) and a copy of the Declarations and Endorsement Page of the CGL policy listing all policy endorsements to Entity before work begins. However, failure to obtain the required documents prior to the work beginning shall not waive the Contractor's obligation to provide them. The Entity reserves the right to require complete, certified copies of all required insurance policies, including endorsements, required by the specifications, at any time.

Subcontractors

Contractor shall require and verify that all subcontractors maintain insurance meeting all requirements stated herein, and Contractor shall ensure that Entity is an additional insured on insurance required from subcontractors, For CGL coverage, subcontractors shall provide coverage with a form at least as broad as CG 20 38 04 13.

Surety Bonds

Contractor shall provide the following Surety Bonds when required by The Port or Port Arthur:

1. Bid Bond
2. Performance Bond
3. Payment Bond
4. Maintenance Bond

The Payment Bond and the Performance Bond shall be in a sum equal to the contract price. If the Performance Bond provides for a one-year warranty a separate Maintenance Bond is not necessary. If the warranty period specified in the contract is for longer than one year a Maintenance Bond equal to 10% of the contract price is required. Bonds shall be duly executed by a responsible corporate surety, authorized to issue such bonds in the State of Texas and secured through an authorized agent with an office in Texas.

Special Risks or Circumstances

Entity reserves the right to modify these requirements, including limits, based on the nature of the risk, prior, experience, insurer, coverage, or other circumstances.

SECTION F
PERFORMANCE BOND

PERFORMANCE BOND: Port of Port Arthur Seafarer Center Parking Lot Expansion Project

KNOW ALL BY THESE PRESENTS: THAT

(Name of Contractor)

(Address of Contractor)

a _____, hereinafter called Principal,
(Corporation, Partnership, or individual)

and _____
(Name of Surety)

(Address of Surety)

hereinafter called Surety, are held and firmly bound unto PORT OF PORT ARTHUR NAVIGATION DISTRICT OF JEFFERSON COUNTY, TEXAS, 221 HOUSTON AVENUE, PORT ARTHUR, TEXAS 77640, hereinafter called OWNER, in the penal sum of _____ Dollars (\$ _____) in lawful money of the United States, for the payment of which sum well and truly to be made, we bind ourselves, successors, and assigns, jointly and severally, firmly by these presents.

THE CONDITION OF THIS OBLIGATION is such that whereas, the Principal entered into a certain contract with the Owner, dated _____, _____ a copy of which is hereto attached and made a part hereof for the construction of the Port of Port Arthur Seafarer Center Parking Lot Expansion Project.

NOW, THEREFORE, if the Principal shall well, truly and faithfully perform its duties, all the undertaking, covenants, terms, conditions, and agreements of said contract during the original term thereof, and any extensions thereof which may be granted by the OWNER, with or without notice to the Surety and during the one year guaranty period, and if he shall satisfy all claims and demands incurred under sub contract, and shall fully indemnify and save harmless the OWNER from all costs and damages which it may suffer by reason of failure to do so, and shall reimburse and repay the OWNER all obligation shall be void; otherwise to remain in full force and effect. Provided, that this bond is executed pursuant to Chapter 2253, Texas Government Code as amended and all liabilities on this bond shall be determined in accordance therewith.

PROVIDED, FURTHER, that the said surety, for value received hereby stipulates and agrees that no change, extension of time, alteration or addition to the terms of the contract or to WORK to be performed thereunder of the SPECIFICATIONS accompanying the same shall in any wise affect its obligation on this BOND, and it does hereby waive notice of any such change, extension of time, alteration or addition to the terms of the contract or to the WORK or to the SPECIFICATIONS.

PROVIDED FURTHER, that no final settlement between the OWNER and the CONTRACTOR shall abridge the right of any beneficiary hereunder, whose claim may be unsatisfied.

IN WITNESS WHEREOF, the said Principal has caused these presents to be executed, and the said surety has caused these presents to be executed, each by its duly authorized agent and officer, and its corporate seal to be affixed at on this _____ day of _____, _____.

This instrument is executed in counterparts, each one of which shall be deemed an original.

Contractor

ATTEST: By: _____

Title: _____

Surety: _____

WITNESS: By: _____

Title: _____

NOTE: Date of Bond must not be prior to date of Contract. If Contractor is Partnership, all partners shall execute Bond. Surety Companies executing Bonds must appear on Treasury Department's most current list (Circular 570 as amended) and authorized to transact business in Texas.

SECTION G
PAYMENT BOND

PAYMENT BOND: Port of Port Arthur Seafarer Center Parking Lot Expansion Project

THE STATE OF TEXAS, COUNTY OF JEFFERSON

KNOW BY ALL THESE PRESENTS, that we

_____ of the City of _____, County of _____ and State of _____ as principal, and, _____, as surety, authorized under the laws of the State of Texas to act as surety on bonds for principals are held and firmly bound unto the Port of Port Arthur Navigation District of Jefferson County, Texas, and to all subcontractors, workmen, laborers, mechanics and furnishers of material, and any other claimant, as their interest may appear, all of whom shall have the right to sue upon their bond, in the penal sum of _____ Dollars (\$ _____), lawful currency of the United States of America, for the payment of which, well and truly to be made, we do hereby bind ourselves, our heirs, executors, administrators and successors, jointly and severally and firmly by these presents:

The condition of this Bond is such that, whereas, the above bounden Principal, as prime contractor, has on the ____ day of _____, 202__, entered in to a formal contract with the Port of Port Arthur Navigation District of Jefferson County, Texas for the Port of Port Arthur Seafarer Center Parking Lot Expansion Project, which is hereby referred to and made part hereof as if fully written herein.

NOW, THEREFORE, if the above bounden Principal shall protect all claimants supplying labor and material as provided for in Chapter 2253, Texas Government Code and shall pay and perform any and every obligation that of such principal is required or provided for in such law, this bond being totally for the protection of all such claimants and being for the use of each such claimant, then this obligation shall be null and void; otherwise it shall remain in full force and effect.

It is stipulated and agreed that no change, extension of time, addition to or modification of the Contract or work performed thereunder, shall in anywise affect the obligation of this bond, and surety expressly waives notice of any such change, extension of time, addition or modification.

IN WITNESS WHEREOF, the said Principal has caused these presents to be executed, and the said surety has caused these presents to be executed, each by its duly authorized agent and officer, and its corporate seal to be affixed at on this ____ day of _____, _____.

Contractor

ATTEST: _____
By: _____
Title: _____

Surety: _____

WITNESS: _____
By: _____
Title: _____

NOTE: Date of Bond must not be prior to date of Contract. If Contractor is Partnership, all partners shall execute Bond. Surety Companies executing Bonds must appear on Treasury Department's most current list (Circular 570 as amended) and be authorized to transact business in Texas.

SECTION H
STANDARD GENERAL CONDITIONS

STANDARD GENERAL CONDITIONS OF THE CONSTRUCTION CONTRACT

TABLE OF CONTENTS

	Page
Article 1—Definitions and Terminology.....	1
1.01 Defined Terms.....	1
1.02 Terminology	6
Article 2—Preliminary Matters.....	7
2.01 Delivery of Performance and Payment Bonds; Evidence of Insurance.....	7
2.02 Copies of Documents	7
2.03 Before Starting Construction	7
2.04 Preconstruction Conference; Designation of Authorized Representatives.....	8
2.05 Acceptance of Schedules	8
2.06 Electronic Transmittals	8
Article 3—Contract Documents: Intent, Requirements, Reuse.....	9
3.01 Intent.....	9
3.02 Reference Standards.....	9
3.03 Reporting and Resolving Discrepancies	10
3.04 Requirements of the Contract Documents.....	10
3.05 Reuse of Documents.....	11
Article 4—Commencement and Progress of the Work	11
4.01 Commencement of Contract Times; Notice to Proceed.....	11
4.02 Starting the Work.....	11
4.03 Reference Points	11
4.04 Progress Schedule.....	12
4.05 Delays in Contractor’s Progress	12
Article 5—Site; Subsurface and Physical Conditions; Hazardous Environmental Conditions	13
5.01 Availability of Lands	13
5.02 Use of Site and Other Areas.....	14
5.03 Subsurface and Physical Conditions.....	15
5.04 Differing Subsurface or Physical Conditions	16

5.05	Underground Facilities.....	17
5.06	Hazardous Environmental Conditions at Site	19
Article 6—Bonds and Insurance.....		21
6.01	Performance, Payment, and Other Bonds.....	21
6.02	Insurance—General Provisions.....	22
6.03	Contractor’s Insurance.....	24
6.04	Builder’s Risk and Other Property Insurance.....	25
6.05	Property Losses; Subrogation	25
6.06	Receipt and Application of Property Insurance Proceeds	27
Article 7—Contractor’s Responsibilities		27
7.01	Contractor’s Means and Methods of Construction	27
7.02	Supervision and Superintendence	27
7.03	Labor; Working Hours	27
7.04	Services, Materials, and Equipment	28
7.05	“Or Equals”.....	28
7.06	Substitutes	29
7.07	Concerning Subcontractors and Suppliers.....	31
7.08	Patent Fees and Royalties.....	32
7.09	Permits	33
7.10	Taxes	33
7.11	Laws and Regulations.....	33
7.12	Record Documents.....	33
7.13	Safety and Protection	34
7.14	Hazard Communication Programs	35
7.15	Emergencies.....	35
7.16	Submittals	35
7.17	Contractor’s General Warranty and Guarantee	38
7.18	Indemnification	39
7.19	Delegation of Professional Design Services	39
Article 8—Other Work at the Site.....		40
8.01	Other Work	40
8.02	Coordination	41
8.03	Legal Relationships.....	41

Article 9—Owner’s Responsibilities	42
9.01 Communications to Contractor	42
9.02 Replacement of Engineer	42
9.03 Furnish Data	42
9.04 Pay When Due.....	42
9.05 Lands and Easements; Reports, Tests, and Drawings.....	43
9.06 Insurance.....	43
9.07 Change Orders	43
9.08 Inspections, Tests, and Approvals.....	43
9.09 Limitations on Owner’s Responsibilities	43
9.10 Undisclosed Hazardous Environmental Condition.....	43
9.11 Evidence of Financial Arrangements.....	43
9.12 Safety Programs	43
Article 10—Engineer’s Status During Construction	44
10.01 Owner’s Representative.....	44
10.02 Visits to Site.....	44
10.03 Resident Project Representative.....	44
10.04 Engineer’s Authority	44
10.05 Determinations for Unit Price Work	45
10.06 Decisions on Requirements of Contract Documents and Acceptability of Work	45
10.07 Limitations on Engineer’s Authority and Responsibilities	45
10.08 Compliance with Safety Program.....	45
Article 11—Changes to the Contract	46
11.01 Amending and Supplementing the Contract	46
11.02 Change Orders	46
11.03 Work Change Directives.....	46
11.04 Field Orders.....	47
11.05 Owner-Authorized Changes in the Work	47
11.06 Unauthorized Changes in the Work.....	47
11.07 Change of Contract Price	47
11.08 Change of Contract Times.....	49
11.09 Change Proposals.....	49
11.10 Notification to Surety.....	50

Article 12—Claims.....	50
12.01 Claims.....	50
Article 13—Cost of the Work; Allowances; Unit Price Work	51
13.01 Cost of the Work	51
13.02 Allowances	55
13.03 Unit Price Work.....	55
Article 14—Tests and Inspections; Correction, Removal, or Acceptance of Defective Work	56
14.01 Access to Work.....	56
14.02 Tests, Inspections, and Approvals.....	56
14.03 Defective Work	57
14.04 Acceptance of Defective Work.....	58
14.05 Uncovering Work	58
14.06 Owner May Stop the Work	58
14.07 Owner May Correct Defective Work.....	59
Article 15—Payments to Contractor; Set-Offs; Completion; Correction Period	59
15.01 Progress Payments.....	59
15.02 Contractor’s Warranty of Title	62
15.03 Substantial Completion.....	62
15.04 Partial Use or Occupancy	63
15.05 Final Inspection	64
15.06 Final Payment.....	64
15.07 Waiver of Claims	65
15.08 Correction Period	66
Article 16—Suspension of Work and Termination	67
16.01 Owner May Suspend Work	67
16.02 Owner May Terminate for Cause.....	67
16.03 Owner May Terminate for Convenience.....	68
16.04 Contractor May Stop Work or Terminate	68
Article 17—Final Resolution of Disputes	69
17.01 Methods and Procedures.....	69
Article 18—Miscellaneous	69
18.01 Giving Notice	69
18.02 Computation of Times.....	69

18.03 Cumulative Remedies 70
18.04 Limitation of Damages 70
18.05 No Waiver 70
18.06 Survival of Obligations 70
18.07 Controlling Law 70
18.08 Assignment of Contract..... 70
18.09 Successors and Assigns 70
18.10 Headings..... 70

STANDARD GENERAL CONDITIONS OF THE CONSTRUCTION CONTRACT

ARTICLE 1—DEFINITIONS AND TERMINOLOGY

1.01 *Defined Terms*

- A. Wherever used in the Bidding Requirements or Contract Documents, a term printed with initial capital letters, including the term's singular and plural forms, will have the meaning indicated in the definitions below. In addition to terms specifically defined, terms with initial capital letters in the Contract Documents include references to identified articles and paragraphs, and the titles of other documents or forms.
1. *Addenda*—Written or graphic instruments issued prior to the opening of Bids which clarify, correct, or change the Bidding Requirements or the proposed Contract Documents.
 2. *Agreement*—The written instrument, executed by Owner and Contractor, that sets forth the Contract Price and Contract Times, identifies the parties and the Engineer, and designates the specific items that are Contract Documents.
 3. *Application for Payment*—The document prepared by Contractor, in a form acceptable to Engineer, to request progress or final payments, and which is to be accompanied by such supporting documentation as is required by the Contract Documents.
 4. *Bid*—The offer of a Bidder submitted on the prescribed form setting forth the prices for the Work to be performed.
 5. *Bidder*—An individual or entity that submits a Bid to Owner.
 6. *Bidding Documents*—The Bidding Requirements, the proposed Contract Documents, and all Addenda.
 7. *Bidding Requirements*—The Advertisement or invitation to bid, Instructions to Bidders, Bid Bond or other Bid security, if any, the Bid Form, and the Bid with any attachments.
 8. *Change Order*—A document which is signed by Contractor and Owner and authorizes an addition, deletion, or revision in the Work or an adjustment in the Contract Price or the Contract Times, or other revision to the Contract, issued on or after the Effective Date of the Contract.
 9. *Change Proposal*—A written request by Contractor, duly submitted in compliance with the procedural requirements set forth herein, seeking an adjustment in Contract Price or Contract Times; contesting an initial decision by Engineer concerning the requirements of the Contract Documents or the acceptability of Work under the Contract Documents; challenging a set-off against payments due; or seeking other relief with respect to the terms of the Contract.
 10. *Claim*
 - a. A demand or assertion by Owner directly to Contractor, duly submitted in compliance with the procedural requirements set forth herein, seeking an adjustment of Contract Price or Contract Times; contesting an initial decision by Engineer concerning the

- requirements of the Contract Documents or the acceptability of Work under the Contract Documents; contesting Engineer's decision regarding a Change Proposal; seeking resolution of a contractual issue that Engineer has declined to address; or seeking other relief with respect to the terms of the Contract.
- b. A demand or assertion by Contractor directly to Owner, duly submitted in compliance with the procedural requirements set forth herein, contesting Engineer's decision regarding a Change Proposal, or seeking resolution of a contractual issue that Engineer has declined to address.
 - c. A demand or assertion by Owner or Contractor, duly submitted in compliance with the procedural requirements set forth herein, made pursuant to Paragraph 12.01.A.4, concerning disputes arising after Engineer has issued a recommendation of final payment.
 - d. A demand for money or services by a third party is not a Claim.
11. *Constituent of Concern*—Asbestos, petroleum, radioactive materials, polychlorinated biphenyls (PCBs), lead-based paint (as defined by the HUD/EPA standard), hazardous waste, and any substance, product, waste, or other material of any nature whatsoever that is or becomes listed, regulated, or addressed pursuant to Laws and Regulations regulating, relating to, or imposing liability or standards of conduct concerning, any hazardous, toxic, or dangerous waste, substance, or material.
 12. *Contract*—The entire and integrated written contract between Owner and Contractor concerning the Work.
 13. *Contract Documents*—Those items so designated in the Agreement, and which together comprise the Contract.
 14. *Contract Price*—The money that Owner has agreed to pay Contractor for completion of the Work in accordance with the Contract Documents.
 15. *Contract Times*—The number of days or the dates by which Contractor shall: (a) achieve Milestones, if any; (b) achieve Substantial Completion; and (c) complete the Work.
 16. *Contractor*—The individual or entity with which Owner has contracted for performance of the Work.
 17. *Cost of the Work*—See Paragraph 13.01 for definition.
 18. *Drawings*—The part of the Contract that graphically shows the scope, extent, and character of the Work to be performed by Contractor.
 19. *Effective Date of the Contract*—The date, indicated in the Agreement, on which the Contract becomes effective.
 20. *Electronic Document*—Any Project-related correspondence, attachments to correspondence, data, documents, drawings, information, or graphics, including but not limited to Shop Drawings and other Submittals, that are in an electronic or digital format.
 21. *Electronic Means*—Electronic mail (email), upload/download from a secure Project website, or other communications methods that allow: (a) the transmission or communication of Electronic Documents; (b) the documentation of transmissions, including sending and receipt; (c) printing of the transmitted Electronic Document by the

recipient; (d) the storage and archiving of the Electronic Document by sender and recipient; and (e) the use by recipient of the Electronic Document for purposes permitted by this Contract. Electronic Means does not include the use of text messaging, or of Facebook, Twitter, Instagram, or similar social media services for transmission of Electronic Documents.

22. *Engineer*—The individual or entity named as such in the Agreement.
23. *Field Order*—A written order issued by Engineer which requires minor changes in the Work but does not change the Contract Price or the Contract Times.
24. *Hazardous Environmental Condition*—The presence at the Site of Constituents of Concern in such quantities or circumstances that may present a danger to persons or property exposed thereto.
 - a. The presence at the Site of materials that are necessary for the execution of the Work, or that are to be incorporated into the Work, and that are controlled and contained pursuant to industry practices, Laws and Regulations, and the requirements of the Contract, is not a Hazardous Environmental Condition.
 - b. The presence of Constituents of Concern that are to be removed or remediated as part of the Work is not a Hazardous Environmental Condition.
 - c. The presence of Constituents of Concern as part of the routine, anticipated, and obvious working conditions at the Site, is not a Hazardous Environmental Condition.
25. *Laws and Regulations; Laws or Regulations*—Any and all applicable laws, statutes, rules, regulations, ordinances, codes, and binding decrees, resolutions, and orders of any and all governmental bodies, agencies, authorities, and courts having jurisdiction.
26. *Liens*—Charges, security interests, or encumbrances upon Contract-related funds, real property, or personal property.
27. *Milestone*—A principal event in the performance of the Work that the Contract requires Contractor to achieve by an intermediate completion date, or by a time prior to Substantial Completion of all the Work.
28. *Notice of Award*—The written notice by Owner to a Bidder of Owner's acceptance of the Bid.
29. *Notice to Proceed*—A written notice by Owner to Contractor fixing the date on which the Contract Times will commence to run and on which Contractor shall start to perform the Work.
30. *Owner*—The individual or entity with which Contractor has contracted regarding the Work, and which has agreed to pay Contractor for the performance of the Work, pursuant to the terms of the Contract.
31. *Progress Schedule*—A schedule, prepared and maintained by Contractor, describing the sequence and duration of the activities comprising Contractor's plan to accomplish the Work within the Contract Times.
32. *Project*—The total undertaking to be accomplished for Owner by engineers, contractors, and others, including planning, study, design, construction, testing, commissioning, and start-up, and of which the Work to be performed under the Contract Documents is a part.

33. *Resident Project Representative*—The authorized representative of Engineer assigned to assist Engineer at the Site. As used herein, the term Resident Project Representative (RPR) includes any assistants or field staff of Resident Project Representative.
34. *Samples*—Physical examples of materials, equipment, or workmanship that are representative of some portion of the Work and that establish the standards by which such portion of the Work will be judged.
35. *Schedule of Submittals*—A schedule, prepared and maintained by Contractor, of required submittals and the time requirements for Engineer’s review of the submittals.
36. *Schedule of Values*—A schedule, prepared and maintained by Contractor, allocating portions of the Contract Price to various portions of the Work and used as the basis for reviewing Contractor’s Applications for Payment.
37. *Shop Drawings*—All drawings, diagrams, illustrations, schedules, and other data or information that are specifically prepared or assembled by or for Contractor and submitted by Contractor to illustrate some portion of the Work. Shop Drawings, whether approved or not, are not Drawings and are not Contract Documents.
38. *Site*—Lands or areas indicated in the Contract Documents as being furnished by Owner upon which the Work is to be performed, including rights-of-way and easements, and such other lands or areas furnished by Owner which are designated for the use of Contractor.
39. *Specifications*—The part of the Contract that consists of written requirements for materials, equipment, systems, standards, and workmanship as applied to the Work, and certain administrative requirements and procedural matters applicable to the Work.
40. *Subcontractor*—An individual or entity having a direct contract with Contractor or with any other Subcontractor for the performance of a part of the Work.
41. *Submittal*—A written or graphic document, prepared by or for Contractor, which the Contract Documents require Contractor to submit to Engineer, or that is indicated as a Submittal in the Schedule of Submittals accepted by Engineer. Submittals may include Shop Drawings and Samples; schedules; product data; Owner-delegated designs; sustainable design information; information on special procedures; testing plans; results of tests and evaluations, source quality-control testing and inspections, and field or Site quality-control testing and inspections; warranties and certifications; Suppliers’ instructions and reports; records of delivery of spare parts and tools; operations and maintenance data; Project photographic documentation; record documents; and other such documents required by the Contract Documents. Submittals, whether or not approved or accepted by Engineer, are not Contract Documents. Change Proposals, Change Orders, Claims, notices, Applications for Payment, and requests for interpretation or clarification are not Submittals.
42. *Substantial Completion*—The time at which the Work (or a specified part thereof) has progressed to the point where, in the opinion of Engineer, the Work (or a specified part thereof) is sufficiently complete, in accordance with the Contract Documents, so that the Work (or a specified part thereof) can be utilized for the purposes for which it is intended. The terms “substantially complete” and “substantially completed” as applied to all or part of the Work refer to Substantial Completion of such Work.

43. *Successful Bidder*—The Bidder to which the Owner makes an award of contract.
44. *Supplementary Conditions*—The part of the Contract that amends or supplements these General Conditions.
45. *Supplier*—A manufacturer, fabricator, supplier, distributor, or vendor having a direct contract with Contractor or with any Subcontractor to furnish materials or equipment to be incorporated in the Work by Contractor or a Subcontractor.
46. *Technical Data*
- a. Those items expressly identified as Technical Data in the Supplementary Conditions, with respect to either (1) existing subsurface conditions at or adjacent to the Site, or existing physical conditions at or adjacent to the Site including existing surface or subsurface structures (except Underground Facilities) or (2) Hazardous Environmental Conditions at the Site.
 - b. If no such express identifications of Technical Data have been made with respect to conditions at the Site, then Technical Data is defined, with respect to conditions at the Site under Paragraphs 5.03, 5.04, and 5.06, as the data contained in boring logs, recorded measurements of subsurface water levels, assessments of the condition of subsurface facilities, laboratory test results, and other factual, objective information regarding conditions at the Site that are set forth in any geotechnical, environmental, or other Site or facilities conditions report prepared for the Project and made available to Contractor.
 - c. Information and data regarding the presence or location of Underground Facilities are not intended to be categorized, identified, or defined as Technical Data, and instead Underground Facilities are shown or indicated on the Drawings.
47. *Underground Facilities*—All active or not-in-service underground lines, pipelines, conduits, ducts, encasements, cables, wires, manholes, vaults, tanks, tunnels, or other such facilities or systems at the Site, including but not limited to those facilities or systems that produce, transmit, distribute, or convey telephone or other communications, cable television, fiber optic transmissions, power, electricity, light, heat, gases, oil, crude oil products, liquid petroleum products, water, steam, waste, wastewater, storm water, other liquids or chemicals, or traffic or other control systems. An abandoned facility or system is not an Underground Facility.
48. *Unit Price Work*—Work to be paid for on the basis of unit prices.
49. *Work*—The entire construction or the various separately identifiable parts thereof required to be provided under the Contract Documents. Work includes and is the result of performing or providing all labor, services, and documentation necessary to produce such construction; furnishing, installing, and incorporating all materials and equipment into such construction; and may include related services such as testing, start-up, and commissioning, all as required by the Contract Documents.
50. *Work Change Directive*—A written directive to Contractor issued on or after the Effective Date of the Contract, signed by Owner and recommended by Engineer, ordering an addition, deletion, or revision in the Work.

1.02 Terminology

- A. The words and terms discussed in Paragraphs 1.02.B, C, D, and E are not defined terms that require initial capital letters, but, when used in the Bidding Requirements or Contract Documents, have the indicated meaning.
- B. *Intent of Certain Terms or Adjectives:* The Contract Documents include the terms “as allowed,” “as approved,” “as ordered,” “as directed” or terms of like effect or import to authorize an exercise of professional judgment by Engineer. In addition, the adjectives “reasonable,” “suitable,” “acceptable,” “proper,” “satisfactory,” or adjectives of like effect or import are used to describe an action or determination of Engineer as to the Work. It is intended that such exercise of professional judgment, action, or determination will be solely to evaluate, in general, the Work for compliance with the information in the Contract Documents and with the design concept of the Project as a functioning whole as shown or indicated in the Contract Documents (unless there is a specific statement indicating otherwise). The use of any such term or adjective is not intended to and shall not be effective to assign to Engineer any duty or authority to supervise or direct the performance of the Work, or any duty or authority to undertake responsibility contrary to the provisions of Article 10 or any other provision of the Contract Documents.
- C. *Day:* The word “day” means a calendar day of 24 hours measured from midnight to the next midnight.
- D. *Defective:* The word “defective,” when modifying the word “Work,” refers to Work that is unsatisfactory, faulty, or deficient in that it:
1. does not conform to the Contract Documents;
 2. does not meet the requirements of any applicable inspection, reference standard, test, or approval referred to in the Contract Documents; or
 3. has been damaged prior to Engineer’s recommendation of final payment (unless responsibility for the protection thereof has been assumed by Owner at Substantial Completion in accordance with Paragraph 15.03 or Paragraph 15.04).
- E. *Furnish, Install, Perform, Provide*
1. The word “furnish,” when used in connection with services, materials, or equipment, means to supply and deliver said services, materials, or equipment to the Site (or some other specified location) ready for use or installation and in usable or operable condition.
 2. The word “install,” when used in connection with services, materials, or equipment, means to put into use or place in final position said services, materials, or equipment complete and ready for intended use.
 3. The words “perform” or “provide,” when used in connection with services, materials, or equipment, means to furnish and install said services, materials, or equipment complete and ready for intended use.
 4. If the Contract Documents establish an obligation of Contractor with respect to specific services, materials, or equipment, but do not expressly use any of the four words “furnish,” “install,” “perform,” or “provide,” then Contractor shall furnish and install said services, materials, or equipment complete and ready for intended use.

- F. *Contract Price or Contract Times*: References to a change in “Contract Price or Contract Times” or “Contract Times or Contract Price” or similar, indicate that such change applies to (1) Contract Price, (2) Contract Times, or (3) both Contract Price and Contract Times, as warranted, even if the term “or both” is not expressed.
- G. Unless stated otherwise in the Contract Documents, words or phrases that have a well-known technical or construction industry or trade meaning are used in the Contract Documents in accordance with such recognized meaning.

ARTICLE 2—PRELIMINARY MATTERS

2.01 *Delivery of Performance and Payment Bonds; Evidence of Insurance*

- A. *Performance and Payment Bonds*: When Contractor delivers the signed counterparts of the Agreement to Owner, Contractor shall also deliver to Owner the performance bond and payment bond (if the Contract requires Contractor to furnish such bonds).
- B. *Evidence of Contractor’s Insurance*: When Contractor delivers the signed counterparts of the Agreement to Owner, Contractor shall also deliver to Owner, with copies to each additional insured (as identified in the Contract), the certificates, endorsements, and other evidence of insurance required to be provided by Contractor in accordance with Article 6, except to the extent the Supplementary Conditions expressly establish other dates for delivery of specific insurance policies.
- C. *Evidence of Owner’s Insurance*: After receipt of the signed counterparts of the Agreement and all required bonds and insurance documentation, Owner shall promptly deliver to Contractor, with copies to each additional insured (as identified in the Contract), the certificates and other evidence of insurance required to be provided by Owner under Article 6.

2.02 *Copies of Documents*

- A. Owner shall furnish to Contractor four printed copies of the Contract (including one fully signed counterpart of the Agreement), and one copy in electronic portable document format (PDF). Additional printed copies will be furnished upon request at the cost of reproduction.
- B. Owner shall maintain and safeguard at least one original printed record version of the Contract, including Drawings and Specifications signed and sealed by Engineer and other design professionals. Owner shall make such original printed record version of the Contract available to Contractor for review. Owner may delegate the responsibilities under this provision to Engineer.

2.03 *Before Starting Construction*

- A. *Preliminary Schedules*: Within 10 days after the Effective Date of the Contract (or as otherwise required by the Contract Documents), Contractor shall submit to Engineer for timely review:
 - 1. a preliminary Progress Schedule indicating the times (numbers of days or dates) for starting and completing the various stages of the Work, including any Milestones specified in the Contract;
 - 2. a preliminary Schedule of Submittals; and
 - 3. a preliminary Schedule of Values for all of the Work which includes quantities and prices of items which when added together equal the Contract Price and subdivides the Work

into component parts in sufficient detail to serve as the basis for progress payments during performance of the Work. Such prices will include an appropriate amount of overhead and profit applicable to each item of Work.

2.04 *Preconstruction Conference; Designation of Authorized Representatives*

- A. Before any Work at the Site is started, a conference attended by Owner, Contractor, Engineer, and others as appropriate will be held to establish a working understanding among the parties as to the Work, and to discuss the schedules referred to in Paragraph 2.03.A, procedures for handling Shop Drawings, Samples, and other Submittals, processing Applications for Payment, electronic or digital transmittals, and maintaining required records.
- B. At this conference Owner and Contractor each shall designate, in writing, a specific individual to act as its authorized representative with respect to the services and responsibilities under the Contract. Such individuals shall have the authority to transmit and receive information, render decisions relative to the Contract, and otherwise act on behalf of each respective party.

2.05 *Acceptance of Schedules*

- A. At least 10 days before submission of the first Application for Payment a conference, attended by Contractor, Engineer, and others as appropriate, will be held to review the schedules submitted in accordance with Paragraph 2.03.A. No progress payment will be made to Contractor until acceptable schedules are submitted to Engineer.
 - 1. The Progress Schedule will be acceptable to Engineer if it provides an orderly progression of the Work to completion within the Contract Times. Such acceptance will not impose on Engineer responsibility for the Progress Schedule, for sequencing, scheduling, or progress of the Work, nor interfere with or relieve Contractor from Contractor's full responsibility therefor.
 - 2. Contractor's Schedule of Submittals will be acceptable to Engineer if it provides a workable arrangement for reviewing and processing the required submittals.
 - 3. Contractor's Schedule of Values will be acceptable to Engineer as to form and substance if it provides a reasonable allocation of the Contract Price to the component parts of the Work.
 - 4. If a schedule is not acceptable, Contractor will have an additional 10 days to revise and resubmit the schedule.

2.06 *Electronic Transmittals*

- A. Except as otherwise stated elsewhere in the Contract, the Owner, Engineer, and Contractor may send, and shall accept, Electronic Documents transmitted by Electronic Means.
- B. If the Contract does not establish protocols for Electronic Means, then Owner, Engineer, and Contractor shall jointly develop such protocols.
- C. Subject to any governing protocols for Electronic Means, when transmitting Electronic Documents by Electronic Means, the transmitting party makes no representations as to long-term compatibility, usability, or readability of the Electronic Documents resulting from the recipient's use of software application packages, operating systems, or computer hardware differing from those used in the drafting or transmittal of the Electronic Documents.

ARTICLE 3—CONTRACT DOCUMENTS: INTENT, REQUIREMENTS, REUSE

3.01 *Intent*

- A. The Contract Documents are complementary; what is required by one Contract Document is as binding as if required by all.
- B. It is the intent of the Contract Documents to describe a functionally complete Project (or part thereof) to be constructed in accordance with the Contract Documents.
- C. Unless otherwise stated in the Contract Documents, if there is a discrepancy between the electronic versions of the Contract Documents (including any printed copies derived from such electronic versions) and the printed record version, the printed record version will govern.
- D. The Contract supersedes prior negotiations, representations, and agreements, whether written or oral.
- E. Engineer will issue clarifications and interpretations of the Contract Documents as provided herein.
- F. Any provision or part of the Contract Documents held to be void or unenforceable under any Law or Regulation will be deemed stricken, and all remaining provisions will continue to be valid and binding upon Owner and Contractor, which agree that the Contract Documents will be reformed to replace such stricken provision or part thereof with a valid and enforceable provision that comes as close as possible to expressing the intention of the stricken provision.
- G. Nothing in the Contract Documents creates:
 - 1. any contractual relationship between Owner or Engineer and any Subcontractor, Supplier, or other individual or entity performing or furnishing any of the Work, for the benefit of such Subcontractor, Supplier, or other individual or entity; or
 - 2. any obligation on the part of Owner or Engineer to pay or to see to the payment of any money due any such Subcontractor, Supplier, or other individual or entity, except as may otherwise be required by Laws and Regulations.

3.02 *Reference Standards*

- A. *Standards Specifications, Codes, Laws and Regulations*
 - 1. Reference in the Contract Documents to standard specifications, manuals, reference standards, or codes of any technical society, organization, or association, or to Laws or Regulations, whether such reference be specific or by implication, means the standard specification, manual, reference standard, code, or Laws or Regulations in effect at the time of opening of Bids (or on the Effective Date of the Contract if there were no Bids), except as may be otherwise specifically stated in the Contract Documents.
 - 2. No provision of any such standard specification, manual, reference standard, or code, and no instruction of a Supplier, will be effective to change the duties or responsibilities of Owner, Contractor, or Engineer from those set forth in the part of the Contract Documents prepared by or for Engineer. No such provision or instruction shall be effective to assign to Owner or Engineer any duty or authority to supervise or direct the performance of the Work, or any duty or authority to undertake responsibility

inconsistent with the provisions of the part of the Contract Documents prepared by or for Engineer.

3.03 *Reporting and Resolving Discrepancies*

A. *Reporting Discrepancies*

1. *Contractor's Verification of Figures and Field Measurements:* Before undertaking each part of the Work, Contractor shall carefully study the Contract Documents, and check and verify pertinent figures and dimensions therein, particularly with respect to applicable field measurements. Contractor shall promptly report in writing to Engineer any conflict, error, ambiguity, or discrepancy that Contractor discovers, or has actual knowledge of, and shall not proceed with any Work affected thereby until the conflict, error, ambiguity, or discrepancy is resolved by a clarification or interpretation by Engineer, or by an amendment or supplement to the Contract issued pursuant to Paragraph 11.01.
2. *Contractor's Review of Contract Documents:* If, before or during the performance of the Work, Contractor discovers any conflict, error, ambiguity, or discrepancy within the Contract Documents, or between the Contract Documents and (a) any applicable Law or Regulation, (b) actual field conditions, (c) any standard specification, manual, reference standard, or code, or (d) any instruction of any Supplier, then Contractor shall promptly report it to Engineer in writing. Contractor shall not proceed with the Work affected thereby (except in an emergency as required by Paragraph 7.15) until the conflict, error, ambiguity, or discrepancy is resolved, by a clarification or interpretation by Engineer, or by an amendment or supplement to the Contract issued pursuant to Paragraph 11.01.
3. Contractor shall not be liable to Owner or Engineer for failure to report any conflict, error, ambiguity, or discrepancy in the Contract Documents unless Contractor had actual knowledge thereof.

B. *Resolving Discrepancies*

1. Except as may be otherwise specifically stated in the Contract Documents, the provisions of the part of the Contract Documents prepared by or for Engineer take precedence in resolving any conflict, error, ambiguity, or discrepancy between such provisions of the Contract Documents and:
 - a. the provisions of any standard specification, manual, reference standard, or code, or the instruction of any Supplier (whether or not specifically incorporated by reference as a Contract Document); or
 - b. the provisions of any Laws or Regulations applicable to the performance of the Work (unless such an interpretation of the provisions of the Contract Documents would result in violation of such Law or Regulation).

3.04 *Requirements of the Contract Documents*

- A. During the performance of the Work and until final payment, Contractor and Owner shall submit to the Engineer in writing all matters in question concerning the requirements of the Contract Documents (sometimes referred to as requests for information or interpretation—RFIs), or relating to the acceptability of the Work under the Contract Documents, as soon as possible after such matters arise. Engineer will be the initial interpreter of the requirements of the Contract Documents, and judge of the acceptability of the Work.

- B. Engineer will, with reasonable promptness, render a written clarification, interpretation, or decision on the issue submitted, or initiate an amendment or supplement to the Contract Documents. Engineer's written clarification, interpretation, or decision will be final and binding on Contractor, unless it appeals by submitting a Change Proposal, and on Owner, unless it appeals by filing a Claim.
- C. If a submitted matter in question concerns terms and conditions of the Contract Documents that do not involve (1) the performance or acceptability of the Work under the Contract Documents, (2) the design (as set forth in the Drawings, Specifications, or otherwise), or (3) other engineering or technical matters, then Engineer will promptly notify Owner and Contractor in writing that Engineer is unable to provide a decision or interpretation. If Owner and Contractor are unable to agree on resolution of such a matter in question, either party may pursue resolution as provided in Article 12.

3.05 *Reuse of Documents*

- A. Contractor and its Subcontractors and Suppliers shall not:
 - 1. have or acquire any title to or ownership rights in any of the Drawings, Specifications, or other documents (or copies of any thereof) prepared by or bearing the seal of Engineer or its consultants, including electronic media versions, or reuse any such Drawings, Specifications, other documents, or copies thereof on extensions of the Project or any other project without written consent of Owner and Engineer and specific written verification or adaptation by Engineer; or
 - 2. have or acquire any title or ownership rights in any other Contract Documents, reuse any such Contract Documents for any purpose without Owner's express written consent, or violate any copyrights pertaining to such Contract Documents.
- B. The prohibitions of this Paragraph 3.05 will survive final payment, or termination of the Contract. Nothing herein precludes Contractor from retaining copies of the Contract Documents for record purposes.

ARTICLE 4—COMMENCEMENT AND PROGRESS OF THE WORK

4.01 *Commencement of Contract Times; Notice to Proceed*

- A. The Contract Times will commence to run on the 30th day after the Effective Date of the Contract or, if a Notice to Proceed is given, on the day indicated in the Notice to Proceed. A Notice to Proceed may be given at any time within 30 days after the Effective Date of the Contract. In no event will the Contract Times commence to run later than the 60th day after the day of Bid opening or the 30th day after the Effective Date of the Contract, whichever date is earlier.

4.02 *Starting the Work*

- A. Contractor shall start to perform the Work on the date when the Contract Times commence to run. No Work may be done at the Site prior to such date.

4.03 *Reference Points*

- A. Owner shall provide engineering surveys to establish reference points for construction which in Engineer's judgment are necessary to enable Contractor to proceed with the Work. Contractor shall be responsible for laying out the Work, shall protect and preserve the

established reference points and property monuments, and shall make no changes or relocations without the prior written approval of Owner. Contractor shall report to Engineer whenever any reference point or property monument is lost or destroyed or requires relocation because of necessary changes in grades or locations, and shall be responsible for the accurate replacement or relocation of such reference points or property monuments by professionally qualified personnel.

4.04 *Progress Schedule*

- A. Contractor shall adhere to the Progress Schedule established in accordance with Paragraph 2.05 as it may be adjusted from time to time as provided below.
 - 1. Contractor shall submit to Engineer for acceptance (to the extent indicated in Paragraph 2.05) proposed adjustments in the Progress Schedule that will not result in changing the Contract Times.
 - 2. Proposed adjustments in the Progress Schedule that will change the Contract Times must be submitted in accordance with the requirements of Article 11.
- B. Contractor shall carry on the Work and adhere to the Progress Schedule during all disputes or disagreements with Owner. No Work will be delayed or postponed pending resolution of any disputes or disagreements, or during any appeal process, except as permitted by Paragraph 16.04, or as Owner and Contractor may otherwise agree in writing.

4.05 *Delays in Contractor's Progress*

- A. If Owner, Engineer, or anyone for whom Owner is responsible, delays, disrupts, or interferes with the performance or progress of the Work, then Contractor shall be entitled to an equitable adjustment in Contract Price or Contract Times.
- B. Contractor shall not be entitled to an adjustment in Contract Price or Contract Times for delay, disruption, or interference caused by or within the control of Contractor. Delay, disruption, and interference attributable to and within the control of a Subcontractor or Supplier shall be deemed to be within the control of Contractor.
- C. If Contractor's performance or progress is delayed, disrupted, or interfered with by unanticipated causes not the fault of and beyond the control of Owner, Contractor, and those for which they are responsible, then Contractor shall be entitled to an equitable adjustment in Contract Times. Such an adjustment will be Contractor's sole and exclusive remedy for the delays, disruption, and interference described in this paragraph. Causes of delay, disruption, or interference that may give rise to an adjustment in Contract Times under this paragraph include but are not limited to the following:
 - 1. Severe and unavoidable natural catastrophes such as fires, floods, epidemics, and earthquakes;
 - 2. Abnormal weather conditions;
 - 3. Acts or failures to act of third-party utility owners or other third-party entities (other than those third-party utility owners or other third-party entities performing other work at or adjacent to the Site as arranged by or under contract with Owner, as contemplated in Article 8); and
 - 4. Acts of war or terrorism.

- D. Contractor's entitlement to an adjustment of Contract Times or Contract Price is limited as follows:
1. Contractor's entitlement to an adjustment of the Contract Times is conditioned on the delay, disruption, or interference adversely affecting an activity on the critical path to completion of the Work, as of the time of the delay, disruption, or interference.
 2. Contractor shall not be entitled to an adjustment in Contract Price for any delay, disruption, or interference if such delay is concurrent with a delay, disruption, or interference caused by or within the control of Contractor. Such a concurrent delay by Contractor shall not preclude an adjustment of Contract Times to which Contractor is otherwise entitled.
 3. Adjustments of Contract Times or Contract Price are subject to the provisions of Article 11.
- E. Each Contractor request or Change Proposal seeking an increase in Contract Times or Contract Price must be supplemented by supporting data that sets forth in detail the following:
1. The circumstances that form the basis for the requested adjustment;
 2. The date upon which each cause of delay, disruption, or interference began to affect the progress of the Work;
 3. The date upon which each cause of delay, disruption, or interference ceased to affect the progress of the Work;
 4. The number of days' increase in Contract Times claimed as a consequence of each such cause of delay, disruption, or interference; and
 5. The impact on Contract Price, in accordance with the provisions of Paragraph 11.07.
- Contractor shall also furnish such additional supporting documentation as Owner or Engineer may require including, where appropriate, a revised progress schedule indicating all the activities affected by the delay, disruption, or interference, and an explanation of the effect of the delay, disruption, or interference on the critical path to completion of the Work.
- F. Delays, disruption, and interference to the performance or progress of the Work resulting from the existence of a differing subsurface or physical condition, an Underground Facility that was not shown or indicated by the Contract Documents, or not shown or indicated with reasonable accuracy, and those resulting from Hazardous Environmental Conditions, are governed by Article 5, together with the provisions of Paragraphs 4.05.D and 4.05.E.
- G. Paragraph 8.03 addresses delays, disruption, and interference to the performance or progress of the Work resulting from the performance of certain other work at or adjacent to the Site.

ARTICLE 5—SITE; SUBSURFACE AND PHYSICAL CONDITIONS; HAZARDOUS ENVIRONMENTAL CONDITIONS

5.01 *Availability of Lands*

- A. Owner shall furnish the Site. Owner shall notify Contractor in writing of any encumbrances or restrictions not of general application but specifically related to use of the Site with which Contractor must comply in performing the Work.

- B. Upon reasonable written request, Owner shall furnish Contractor with a current statement of record legal title and legal description of the lands upon which permanent improvements are to be made and Owner's interest therein as necessary for giving notice of or filing a mechanic's or construction lien against such lands in accordance with applicable Laws and Regulations.
- C. Contractor shall provide for all additional lands and access thereto that may be required for temporary construction facilities or storage of materials and equipment.

5.02 *Use of Site and Other Areas*

A. *Limitation on Use of Site and Other Areas*

1. Contractor shall confine construction equipment, temporary construction facilities, the storage of materials and equipment, and the operations of workers to the Site, adjacent areas that Contractor has arranged to use through construction easements or otherwise, and other adjacent areas permitted by Laws and Regulations, and shall not unreasonably encumber the Site and such other adjacent areas with construction equipment or other materials or equipment. Contractor shall assume full responsibility for (a) damage to the Site; (b) damage to any such other adjacent areas used for Contractor's operations; (c) damage to any other adjacent land or areas, or to improvements, structures, utilities, or similar facilities located at such adjacent lands or areas; and (d) for injuries and losses sustained by the owners or occupants of any such land or areas; provided that such damage or injuries result from the performance of the Work or from other actions or conduct of the Contractor or those for which Contractor is responsible.
 2. If a damage or injury claim is made by the owner or occupant of any such land or area because of the performance of the Work, or because of other actions or conduct of the Contractor or those for which Contractor is responsible, Contractor shall (a) take immediate corrective or remedial action as required by Paragraph 7.13, or otherwise; (b) promptly attempt to settle the claim as to all parties through negotiations with such owner or occupant, or otherwise resolve the claim by arbitration or other dispute resolution proceeding, or in a court of competent jurisdiction; and (c) to the fullest extent permitted by Laws and Regulations, indemnify and hold harmless Owner and Engineer, and the officers, directors, members, partners, employees, agents, consultants and subcontractors of each and any of them, from and against any such claim, and against all costs, losses, and damages (including but not limited to all fees and charges of engineers, architects, attorneys, and other professionals and all court or arbitration or other dispute resolution costs) arising out of or relating to any claim or action, legal or equitable, brought by any such owner or occupant against Owner, Engineer, or any other party indemnified hereunder to the extent caused directly or indirectly, in whole or in part by, or based upon, Contractor's performance of the Work, or because of other actions or conduct of the Contractor or those for which Contractor is responsible.
- B. *Removal of Debris During Performance of the Work:* During the progress of the Work the Contractor shall keep the Site and other adjacent areas free from accumulations of waste materials, rubbish, and other debris. Removal and disposal of such waste materials, rubbish, and other debris will conform to applicable Laws and Regulations.
 - C. *Cleaning:* Prior to Substantial Completion of the Work Contractor shall clean the Site and the Work and make it ready for utilization by Owner. At the completion of the Work Contractor shall remove from the Site and adjacent areas all tools, appliances, construction equipment

and machinery, and surplus materials and shall restore to original condition all property not designated for alteration by the Contract Documents.

- D. *Loading of Structures:* Contractor shall not load nor permit any part of any structure to be loaded in any manner that will endanger the structure, nor shall Contractor subject any part of the Work or adjacent structures or land to stresses or pressures that will endanger them.

5.03 *Subsurface and Physical Conditions*

- A. *Reports and Drawings:* The Supplementary Conditions identify:

1. Those reports of explorations and tests of subsurface conditions at or adjacent to the Site that contain Technical Data;
2. Those drawings of existing physical conditions at or adjacent to the Site, including those drawings depicting existing surface or subsurface structures at or adjacent to the Site (except Underground Facilities), that contain Technical Data; and
3. Technical Data contained in such reports and drawings.

- B. *Underground Facilities:* Underground Facilities are shown or indicated on the Drawings, pursuant to Paragraph 5.05, and not in the drawings referred to in Paragraph 5.03.A. Information and data regarding the presence or location of Underground Facilities are not intended to be categorized, identified, or defined as Technical Data.

- C. *Reliance by Contractor on Technical Data:* Contractor may rely upon the accuracy of the Technical Data expressly identified in the Supplementary Conditions with respect to such reports and drawings, but such reports and drawings are not Contract Documents. If no such express identification has been made, then Contractor may rely upon the accuracy of the Technical Data as defined in Paragraph 1.01.A.46.b.

- D. *Limitations of Other Data and Documents:* Except for such reliance on Technical Data, Contractor may not rely upon or make any claim against Owner or Engineer, or any of their officers, directors, members, partners, employees, agents, consultants, or subcontractors, with respect to:

1. the completeness of such reports and drawings for Contractor's purposes, including, but not limited to, any aspects of the means, methods, techniques, sequences, and procedures of construction to be employed by Contractor, and safety precautions and programs incident thereto;
2. other data, interpretations, opinions, and information contained in such reports or shown or indicated in such drawings;
3. the contents of other Site-related documents made available to Contractor, such as record drawings from other projects at or adjacent to the Site, or Owner's archival documents concerning the Site; or
4. any Contractor interpretation of or conclusion drawn from any Technical Data or any such other data, interpretations, opinions, or information.

5.04 *Differing Subsurface or Physical Conditions*

- A. *Notice by Contractor:* If Contractor believes that any subsurface or physical condition that is uncovered or revealed at the Site:
1. is of such a nature as to establish that any Technical Data on which Contractor is entitled to rely as provided in Paragraph 5.03 is materially inaccurate;
 2. is of such a nature as to require a change in the Drawings or Specifications;
 3. differs materially from that shown or indicated in the Contract Documents; or
 4. is of an unusual nature, and differs materially from conditions ordinarily encountered and generally recognized as inherent in work of the character provided for in the Contract Documents;

then Contractor shall, promptly after becoming aware thereof and before further disturbing the subsurface or physical conditions or performing any Work in connection therewith (except in an emergency as required by Paragraph 7.15), notify Owner and Engineer in writing about such condition. Contractor shall not further disturb such condition or perform any Work in connection therewith (except with respect to an emergency) until receipt of a written statement permitting Contractor to do so.

- B. *Engineer's Review:* After receipt of written notice as required by the preceding paragraph, Engineer will promptly review the subsurface or physical condition in question; determine whether it is necessary for Owner to obtain additional exploration or tests with respect to the condition; conclude whether the condition falls within any one or more of the differing site condition categories in Paragraph 5.04.A; obtain any pertinent cost or schedule information from Contractor; prepare recommendations to Owner regarding the Contractor's resumption of Work in connection with the subsurface or physical condition in question and the need for any change in the Drawings or Specifications; and advise Owner in writing of Engineer's findings, conclusions, and recommendations.
- C. *Owner's Statement to Contractor Regarding Site Condition:* After receipt of Engineer's written findings, conclusions, and recommendations, Owner shall issue a written statement to Contractor (with a copy to Engineer) regarding the subsurface or physical condition in question, addressing the resumption of Work in connection with such condition, indicating whether any change in the Drawings or Specifications will be made, and adopting or rejecting Engineer's written findings, conclusions, and recommendations, in whole or in part.
- D. *Early Resumption of Work:* If at any time Engineer determines that Work in connection with the subsurface or physical condition in question may resume prior to completion of Engineer's review or Owner's issuance of its statement to Contractor, because the condition in question has been adequately documented, and analyzed on a preliminary basis, then the Engineer may at its discretion instruct Contractor to resume such Work.
- E. *Possible Price and Times Adjustments*
1. Contractor shall be entitled to an equitable adjustment in Contract Price or Contract Times, to the extent that the existence of a differing subsurface or physical condition, or any related delay, disruption, or interference, causes an increase or decrease in

Contractor's cost of, or time required for, performance of the Work; subject, however, to the following:

- a. Such condition must fall within any one or more of the categories described in Paragraph 5.04.A;
 - b. With respect to Work that is paid for on a unit price basis, any adjustment in Contract Price will be subject to the provisions of Paragraph 13.03; and,
 - c. Contractor's entitlement to an adjustment of the Contract Times is subject to the provisions of Paragraphs 4.05.D and 4.05.E.
2. Contractor shall not be entitled to any adjustment in the Contract Price or Contract Times with respect to a subsurface or physical condition if:
- a. Contractor knew of the existence of such condition at the time Contractor made a commitment to Owner with respect to Contract Price and Contract Times by the submission of a Bid or becoming bound under a negotiated contract, or otherwise;
 - b. The existence of such condition reasonably could have been discovered or revealed as a result of any examination, investigation, exploration, test, or study of the Site and contiguous areas expressly required by the Bidding Requirements or Contract Documents to be conducted by or for Contractor prior to Contractor's making such commitment; or
 - c. Contractor failed to give the written notice required by Paragraph 5.04.A.
3. If Owner and Contractor agree regarding Contractor's entitlement to and the amount or extent of any adjustment in the Contract Price or Contract Times, then any such adjustment will be set forth in a Change Order.
4. Contractor may submit a Change Proposal regarding its entitlement to or the amount or extent of any adjustment in the Contract Price or Contract Times, no later than 30 days after Owner's issuance of the Owner's written statement to Contractor regarding the subsurface or physical condition in question.
- F. *Underground Facilities; Hazardous Environmental Conditions*: Paragraph 5.05 governs rights and responsibilities regarding the presence or location of Underground Facilities. Paragraph 5.06 governs rights and responsibilities regarding Hazardous Environmental Conditions. The provisions of Paragraphs 5.03 and 5.04 are not applicable to the presence or location of Underground Facilities, or to Hazardous Environmental Conditions.

5.05 *Underground Facilities*

- A. *Contractor's Responsibilities*: Unless it is otherwise expressly provided in the Supplementary Conditions, the cost of all of the following are included in the Contract Price, and Contractor shall have full responsibility for:
1. reviewing and checking all information and data regarding existing Underground Facilities at the Site;
 2. complying with applicable state and local utility damage prevention Laws and Regulations;

3. verifying the actual location of those Underground Facilities shown or indicated in the Contract Documents as being within the area affected by the Work, by exposing such Underground Facilities during the course of construction;
 4. coordination of the Work with the owners (including Owner) of such Underground Facilities, during construction; and
 5. the safety and protection of all existing Underground Facilities at the Site, and repairing any damage thereto resulting from the Work.
- B. *Notice by Contractor:* If Contractor believes that an Underground Facility that is uncovered or revealed at the Site was not shown or indicated on the Drawings, or was not shown or indicated on the Drawings with reasonable accuracy, then Contractor shall, promptly after becoming aware thereof and before further disturbing conditions affected thereby or performing any Work in connection therewith (except in an emergency as required by Paragraph 7.15), notify Owner and Engineer in writing regarding such Underground Facility.
- C. *Engineer's Review:* Engineer will:
1. promptly review the Underground Facility and conclude whether such Underground Facility was not shown or indicated on the Drawings, or was not shown or indicated with reasonable accuracy;
 2. identify and communicate with the owner of the Underground Facility; prepare recommendations to Owner (and if necessary issue any preliminary instructions to Contractor) regarding the Contractor's resumption of Work in connection with the Underground Facility in question;
 3. obtain any pertinent cost or schedule information from Contractor; determine the extent, if any, to which a change is required in the Drawings or Specifications to reflect and document the consequences of the existence or location of the Underground Facility; and
 4. advise Owner in writing of Engineer's findings, conclusions, and recommendations.

During such time, Contractor shall be responsible for the safety and protection of such Underground Facility.

- D. *Owner's Statement to Contractor Regarding Underground Facility:* After receipt of Engineer's written findings, conclusions, and recommendations, Owner shall issue a written statement to Contractor (with a copy to Engineer) regarding the Underground Facility in question addressing the resumption of Work in connection with such Underground Facility, indicating whether any change in the Drawings or Specifications will be made, and adopting or rejecting Engineer's written findings, conclusions, and recommendations in whole or in part.
- E. *Early Resumption of Work:* If at any time Engineer determines that Work in connection with the Underground Facility may resume prior to completion of Engineer's review or Owner's issuance of its statement to Contractor, because the Underground Facility in question and conditions affected by its presence have been adequately documented, and analyzed on a preliminary basis, then the Engineer may at its discretion instruct Contractor to resume such Work.
- F. *Possible Price and Times Adjustments*
1. Contractor shall be entitled to an equitable adjustment in the Contract Price or Contract Times, to the extent that any existing Underground Facility at the Site that was not shown

or indicated on the Drawings, or was not shown or indicated with reasonable accuracy, or any related delay, disruption, or interference, causes an increase or decrease in Contractor's cost of, or time required for, performance of the Work; subject, however, to the following:

- a. With respect to Work that is paid for on a unit price basis, any adjustment in Contract Price will be subject to the provisions of Paragraph 13.03;
 - b. Contractor's entitlement to an adjustment of the Contract Times is subject to the provisions of Paragraphs 4.05.D and 4.05.E; and
 - c. Contractor gave the notice required in Paragraph 5.05.B.
2. If Owner and Contractor agree regarding Contractor's entitlement to and the amount or extent of any adjustment in the Contract Price or Contract Times, then any such adjustment will be set forth in a Change Order.
 3. Contractor may submit a Change Proposal regarding its entitlement to or the amount or extent of any adjustment in the Contract Price or Contract Times, no later than 30 days after Owner's issuance of the Owner's written statement to Contractor regarding the Underground Facility in question.
 4. The information and data shown or indicated on the Drawings with respect to existing Underground Facilities at the Site is based on information and data (a) furnished by the owners of such Underground Facilities, or by others, (b) obtained from available records, or (c) gathered in an investigation conducted in accordance with the current edition of ASCE 38, Standard Guideline for the Collection and Depiction of Existing Subsurface Utility Data, by the American Society of Civil Engineers. If such information or data is incorrect or incomplete, Contractor's remedies are limited to those set forth in this Paragraph 5.05.F.

5.06 *Hazardous Environmental Conditions at Site*

A. *Reports and Drawings:* The Supplementary Conditions identify:

1. those reports known to Owner relating to Hazardous Environmental Conditions that have been identified at or adjacent to the Site;
2. drawings known to Owner relating to Hazardous Environmental Conditions that have been identified at or adjacent to the Site; and
3. Technical Data contained in such reports and drawings.

B. *Reliance by Contractor on Technical Data Authorized:* Contractor may rely upon the accuracy of the Technical Data expressly identified in the Supplementary Conditions with respect to such reports and drawings, but such reports and drawings are not Contract Documents. If no such express identification has been made, then Contractor may rely on the accuracy of the Technical Data as defined in Paragraph 1.01.A.46.b. Except for such reliance on Technical Data, Contractor may not rely upon or make any claim against Owner or Engineer, or any of their officers, directors, members, partners, employees, agents, consultants, or subcontractors, with respect to:

1. the completeness of such reports and drawings for Contractor's purposes, including, but not limited to, any aspects of the means, methods, techniques, sequences and procedures

- of construction to be employed by Contractor, and safety precautions and programs incident thereto;
2. other data, interpretations, opinions, and information contained in such reports or shown or indicated in such drawings; or
 3. any Contractor interpretation of or conclusion drawn from any Technical Data or any such other data, interpretations, opinions or information.
- C. Contractor shall not be responsible for removing or remediating any Hazardous Environmental Condition encountered, uncovered, or revealed at the Site unless such removal or remediation is expressly identified in the Contract Documents to be within the scope of the Work.
- D. Contractor shall be responsible for controlling, containing, and duly removing all Constituents of Concern brought to the Site by Contractor, Subcontractors, Suppliers, or anyone else for whom Contractor is responsible, and for any associated costs; and for the costs of removing and remediating any Hazardous Environmental Condition created by the presence of any such Constituents of Concern.
- E. If Contractor encounters, uncovers, or reveals a Hazardous Environmental Condition whose removal or remediation is not expressly identified in the Contract Documents as being within the scope of the Work, or if Contractor or anyone for whom Contractor is responsible creates a Hazardous Environmental Condition, then Contractor shall immediately: (1) secure or otherwise isolate such condition; (2) stop all Work in connection with such condition and in any area affected thereby (except in an emergency as required by Paragraph 7.15); and (3) notify Owner and Engineer (and promptly thereafter confirm such notice in writing). Owner shall promptly consult with Engineer concerning the necessity for Owner to retain a qualified expert to evaluate such condition or take corrective action, if any. Promptly after consulting with Engineer, Owner shall take such actions as are necessary to permit Owner to timely obtain required permits and provide Contractor the written notice required by Paragraph 5.06.F. If Contractor or anyone for whom Contractor is responsible created the Hazardous Environmental Condition in question, then Owner may remove and remediate the Hazardous Environmental Condition, and impose a set-off against payments to account for the associated costs.
- F. Contractor shall not resume Work in connection with such Hazardous Environmental Condition or in any affected area until after Owner has obtained any required permits related thereto, and delivered written notice to Contractor either (1) specifying that such condition and any affected area is or has been rendered safe for the resumption of Work, or (2) specifying any special conditions under which such Work may be resumed safely.
- G. If Owner and Contractor cannot agree as to entitlement to or on the amount or extent, if any, of any adjustment in Contract Price or Contract Times, as a result of such Work stoppage, such special conditions under which Work is agreed to be resumed by Contractor, or any costs or expenses incurred in response to the Hazardous Environmental Condition, then within 30 days of Owner's written notice regarding the resumption of Work, Contractor may submit a Change Proposal, or Owner may impose a set-off. Entitlement to any such adjustment is subject to the provisions of Paragraphs 4.05.D, 4.05.E, 11.07, and 11.08.
- H. If, after receipt of such written notice, Contractor does not agree to resume such Work based on a reasonable belief it is unsafe, or does not agree to resume such Work under such special

conditions, then Owner may order the portion of the Work that is in the area affected by such condition to be deleted from the Work, following the contractual change procedures in Article 11. Owner may have such deleted portion of the Work performed by Owner's own forces or others in accordance with Article 8.

- I. To the fullest extent permitted by Laws and Regulations, Owner shall indemnify and hold harmless Contractor, Subcontractors, and Engineer, and the officers, directors, members, partners, employees, agents, consultants, and subcontractors of each and any of them, from and against all claims, costs, losses, and damages (including but not limited to all fees and charges of engineers, architects, attorneys, and other professionals, and all court, arbitration, or other dispute resolution costs) arising out of or relating to a Hazardous Environmental Condition, provided that such Hazardous Environmental Condition (1) was not shown or indicated in the Drawings, Specifications, or other Contract Documents, identified as Technical Data entitled to limited reliance pursuant to Paragraph 5.06.B, or identified in the Contract Documents to be included within the scope of the Work, and (2) was not created by Contractor or by anyone for whom Contractor is responsible. Nothing in this Paragraph 5.06.I obligates Owner to indemnify any individual or entity from and against the consequences of that individual's or entity's own negligence.
- J. To the fullest extent permitted by Laws and Regulations, Contractor shall indemnify and hold harmless Owner and Engineer, and the officers, directors, members, partners, employees, agents, consultants, and subcontractors of each and any of them, from and against all claims, costs, losses, and damages (including but not limited to all fees and charges of engineers, architects, attorneys, and other professionals and all court or arbitration or other dispute resolution costs) arising out of or relating to the failure to control, contain, or remove a Constituent of Concern brought to the Site by Contractor or by anyone for whom Contractor is responsible, or to a Hazardous Environmental Condition created by Contractor or by anyone for whom Contractor is responsible. Nothing in this Paragraph 5.06.J obligates Contractor to indemnify any individual or entity from and against the consequences of that individual's or entity's own negligence.
- K. The provisions of Paragraphs 5.03, 5.04, and 5.05 do not apply to the presence of Constituents of Concern or to a Hazardous Environmental Condition uncovered or revealed at the Site.

ARTICLE 6—BONDS AND INSURANCE

6.01 *Performance, Payment, and Other Bonds*

- A. Contractor shall furnish a performance bond and a payment bond, each in an amount at least equal to the Contract Price, as security for the faithful performance and payment of Contractor's obligations under the Contract. These bonds must remain in effect until one year after the date when final payment becomes due or until completion of the correction period specified in Paragraph 15.08, whichever is later, except as provided otherwise by Laws or Regulations, the terms of a prescribed bond form, the Supplementary Conditions, or other provisions of the Contract.
- B. Contractor shall also furnish such other bonds (if any) as are required by the Supplementary Conditions or other provisions of the Contract.
- C. All bonds must be in the form included in the Bidding Documents or otherwise specified by Owner prior to execution of the Contract, except as provided otherwise by Laws or

Regulations, and must be issued and signed by a surety named in “Companies Holding Certificates of Authority as Acceptable Sureties on Federal Bonds and as Acceptable Reinsuring Companies” as published in Department Circular 570 (as amended and supplemented) by the Bureau of the Fiscal Service, U.S. Department of the Treasury. A bond signed by an agent or attorney-in-fact must be accompanied by a certified copy of that individual’s authority to bind the surety. The evidence of authority must show that it is effective on the date the agent or attorney-in-fact signed the accompanying bond.

- D. Contractor shall obtain the required bonds from surety companies that are duly licensed or authorized, in the state or jurisdiction in which the Project is located, to issue bonds in the required amounts.
- E. If the surety on a bond furnished by Contractor is declared bankrupt or becomes insolvent, or the surety ceases to meet the requirements above, then Contractor shall promptly notify Owner and Engineer in writing and shall, within 20 days after the event giving rise to such notification, provide another bond and surety, both of which must comply with the bond and surety requirements above.
- F. If Contractor has failed to obtain a required bond, Owner may exclude the Contractor from the Site and exercise Owner’s termination rights under Article 16.
- G. Upon request to Owner from any Subcontractor, Supplier, or other person or entity claiming to have furnished labor, services, materials, or equipment used in the performance of the Work, Owner shall provide a copy of the payment bond to such person or entity.
- H. Upon request to Contractor from any Subcontractor, Supplier, or other person or entity claiming to have furnished labor, services, materials, or equipment used in the performance of the Work, Contractor shall provide a copy of the payment bond to such person or entity.

6.02 *Insurance—General Provisions*

- A. Owner and Contractor shall obtain and maintain insurance as required in this article and in the Supplementary Conditions.
- B. All insurance required by the Contract to be purchased and maintained by Owner or Contractor shall be obtained from insurance companies that are duly licensed or authorized in the state or jurisdiction in which the Project is located to issue insurance policies for the required limits and coverages. Unless a different standard is indicated in the Supplementary Conditions, all companies that provide insurance policies required under this Contract shall have an A.M. Best rating of A-VII or better.
- C. Alternative forms of insurance coverage, including but not limited to self-insurance and “Occupational Accident and Excess Employer’s Indemnity Policies,” are not sufficient to meet the insurance requirements of this Contract, unless expressly allowed in the Supplementary Conditions.
- D. Contractor shall deliver to Owner, with copies to each additional insured identified in the Contract, certificates of insurance and endorsements establishing that Contractor has obtained and is maintaining the policies and coverages required by the Contract. Upon request by Owner or any other insured, Contractor shall also furnish other evidence of such required insurance, including but not limited to copies of policies, documentation of applicable self-insured retentions (if allowed) and deductibles, full disclosure of all relevant exclusions, and evidence of insurance required to be purchased and maintained by

Subcontractors or Suppliers. In any documentation furnished under this provision, Contractor, Subcontractors, and Suppliers may block out (redact) (1) any confidential premium or pricing information and (2) any wording specific to a project or jurisdiction other than those applicable to this Contract.

- E. Owner shall deliver to Contractor, with copies to each additional insured identified in the Contract, certificates of insurance and endorsements establishing that Owner has obtained and is maintaining the policies and coverages required of Owner by the Contract (if any). Upon request by Contractor or any other insured, Owner shall also provide other evidence of such required insurance (if any), including but not limited to copies of policies, documentation of applicable self-insured retentions (if allowed) and deductibles, and full disclosure of all relevant exclusions. In any documentation furnished under this provision, Owner may block out (redact) (1) any confidential premium or pricing information and (2) any wording specific to a project or jurisdiction other than those relevant to this Contract.
- F. Failure of Owner or Contractor to demand such certificates or other evidence of the other party's full compliance with these insurance requirements, or failure of Owner or Contractor to identify a deficiency in compliance from the evidence provided, will not be construed as a waiver of the other party's obligation to obtain and maintain such insurance.
- G. In addition to the liability insurance required to be provided by Contractor, the Owner, at Owner's option, may purchase and maintain Owner's own liability insurance. Owner's liability policies, if any, operate separately and independently from policies required to be provided by Contractor, and Contractor cannot rely upon Owner's liability policies for any of Contractor's obligations to the Owner, Engineer, or third parties.
- H. Contractor shall require:
 - 1. Subcontractors to purchase and maintain worker's compensation, commercial general liability, and other insurance that is appropriate for their participation in the Project, and to name as additional insureds Owner and Engineer (and any other individuals or entities identified in the Supplementary Conditions as additional insureds on Contractor's liability policies) on each Subcontractor's commercial general liability insurance policy; and
 - 2. Suppliers to purchase and maintain insurance that is appropriate for their participation in the Project.
- I. If either party does not purchase or maintain the insurance required of such party by the Contract, such party shall notify the other party in writing of such failure to purchase prior to the start of the Work, or of such failure to maintain prior to any change in the required coverage.
- J. If Contractor has failed to obtain and maintain required insurance, Contractor's entitlement to enter or remain at the Site will end immediately, and Owner may impose an appropriate set-off against payment for any associated costs (including but not limited to the cost of purchasing necessary insurance coverage), and exercise Owner's termination rights under Article 16.
- K. Without prejudice to any other right or remedy, if a party has failed to obtain required insurance, the other party may elect (but is in no way obligated) to obtain equivalent insurance to protect such other party's interests at the expense of the party who was required to provide such coverage, and the Contract Price will be adjusted accordingly.

- L. Owner does not represent that insurance coverage and limits established in this Contract necessarily will be adequate to protect Contractor or Contractor's interests. Contractor is responsible for determining whether such coverage and limits are adequate to protect its interests, and for obtaining and maintaining any additional insurance that Contractor deems necessary.
- M. The insurance and insurance limits required herein will not be deemed as a limitation on Contractor's liability, or that of its Subcontractors or Suppliers, under the indemnities granted to Owner and other individuals and entities in the Contract or otherwise.
- N. All the policies of insurance required to be purchased and maintained under this Contract will contain a provision or endorsement that the coverage afforded will not be canceled, or renewal refused, until at least 10 days prior written notice has been given to the purchasing policyholder. Within three days of receipt of any such written notice, the purchasing policyholder shall provide a copy of the notice to each other insured and Engineer.

6.03 Contractor's Insurance

- A. *Required Insurance:* Contractor shall purchase and maintain Worker's Compensation, Commercial General Liability, and other insurance pursuant to the specific requirements of the Supplementary Conditions.
- B. *General Provisions:* The policies of insurance required by this Paragraph 6.03 as supplemented must:
 - 1. include at least the specific coverages required;
 - 2. be written for not less than the limits provided, or those required by Laws or Regulations, whichever is greater;
 - 3. remain in effect at least until the Work is complete (as set forth in Paragraph 15.06.D), and longer if expressly required elsewhere in this Contract, and at all times thereafter when Contractor may be correcting, removing, or replacing defective Work as a warranty or correction obligation, or otherwise, or returning to the Site to conduct other tasks arising from the Contract;
 - 4. apply with respect to the performance of the Work, whether such performance is by Contractor, any Subcontractor or Supplier, or by anyone directly or indirectly employed by any of them to perform any of the Work, or by anyone for whose acts any of them may be liable; and
 - 5. include all necessary endorsements to support the stated requirements.
- C. *Additional Insureds:* The Contractor's commercial general liability, automobile liability, employer's liability, umbrella or excess, pollution liability, and unmanned aerial vehicle liability policies, if required by this Contract, must:
 - 1. include and list as additional insureds Owner and Engineer, and any individuals or entities identified as additional insureds in the Supplementary Conditions;
 - 2. include coverage for the respective officers, directors, members, partners, employees, and consultants of all such additional insureds;
 - 3. afford primary coverage to these additional insureds for all claims covered thereby (including as applicable those arising from both ongoing and completed operations);

4. not seek contribution from insurance maintained by the additional insured; and
5. as to commercial general liability insurance, apply to additional insureds with respect to liability caused in whole or in part by Contractor's acts or omissions, or the acts and omissions of those working on Contractor's behalf, in the performance of Contractor's operations.

6.04 *Builder's Risk and Other Property Insurance*

- A. *Builder's Risk*: Unless otherwise provided in the Supplementary Conditions, Contractor shall purchase and maintain builder's risk insurance upon the Work on a completed value basis, in the amount of the Work's full insurable replacement cost (subject to such deductible amounts as may be provided in the Supplementary Conditions or required by Laws and Regulations). The specific requirements applicable to the builder's risk insurance are set forth in the Supplementary Conditions.
- B. *Property Insurance for Facilities of Owner Where Work Will Occur*: Owner is responsible for obtaining and maintaining property insurance covering each existing structure, building, or facility in which any part of the Work will occur, or to which any part of the Work will attach or be adjoined. Such property insurance will be written on a special perils (all-risk) form, on a replacement cost basis, providing coverage consistent with that required for the builder's risk insurance, and will be maintained until the Work is complete, as set forth in Paragraph 15.06.D.
- C. *Property Insurance for Substantially Complete Facilities*: Promptly after Substantial Completion, and before actual occupancy or use of the substantially completed Work, Owner will obtain property insurance for such substantially completed Work, and maintain such property insurance at least until the Work is complete, as set forth in Paragraph 15.06.D. Such property insurance will be written on a special perils (all-risk) form, on a replacement cost basis, and provide coverage consistent with that required for the builder's risk insurance. The builder's risk insurance may terminate upon written confirmation of Owner's procurement of such property insurance.
- D. *Partial Occupancy or Use by Owner*: If Owner will occupy or use a portion or portions of the Work prior to Substantial Completion of all the Work, as provided in Paragraph 15.04, then Owner (directly, if it is the purchaser of the builder's risk policy, or through Contractor) will provide advance notice of such occupancy or use to the builder's risk insurer, and obtain an endorsement consenting to the continuation of coverage prior to commencing such partial occupancy or use.
- E. *Insurance of Other Property; Additional Insurance*: If the express insurance provisions of the Contract do not require or address the insurance of a property item or interest, then the entity or individual owning such property item will be responsible for insuring it. If Contractor elects to obtain other special insurance to be included in or supplement the builder's risk or property insurance policies provided under this Paragraph 6.04, it may do so at Contractor's expense.

6.05 *Property Losses; Subrogation*

- A. The builder's risk insurance policy purchased and maintained in accordance with Paragraph 6.04 (or an installation floater policy if authorized by the Supplementary Conditions), will contain provisions to the effect that in the event of payment of any loss or damage the insurer will have no rights of recovery against any insureds thereunder, or against

Engineer or its consultants, or their officers, directors, members, partners, employees, agents, consultants, or subcontractors.

1. Owner and Contractor waive all rights against each other and the respective officers, directors, members, partners, employees, agents, consultants, and subcontractors of each and any of them, for all losses and damages caused by, arising out of, or resulting from any of the perils, risks, or causes of loss covered by such policies and any other property insurance applicable to the Work; and, in addition, waive all such rights against Engineer, its consultants, all individuals or entities identified in the Supplementary Conditions as builder's risk or installation floater insureds, and the officers, directors, members, partners, employees, agents, consultants, and subcontractors of each and any of them, under such policies for losses and damages so caused.
 2. None of the above waivers extends to the rights that any party making such waiver may have to the proceeds of insurance held by Owner or Contractor as trustee or fiduciary, or otherwise payable under any policy so issued.
- B. Any property insurance policy maintained by Owner covering any loss, damage, or consequential loss to Owner's existing structures, buildings, or facilities in which any part of the Work will occur, or to which any part of the Work will attach or adjoin; to adjacent structures, buildings, or facilities of Owner; or to part or all of the completed or substantially completed Work, during partial occupancy or use pursuant to Paragraph 15.04, after Substantial Completion pursuant to Paragraph 15.03, or after final payment pursuant to Paragraph 15.06, will contain provisions to the effect that in the event of payment of any loss or damage the insurer will have no rights of recovery against any insureds thereunder, or against Contractor, Subcontractors, or Engineer, or the officers, directors, members, partners, employees, agents, consultants, or subcontractors of each and any of them, and that the insured is allowed to waive the insurer's rights of subrogation in a written contract executed prior to the loss, damage, or consequential loss.
1. Owner waives all rights against Contractor, Subcontractors, and Engineer, and the officers, directors, members, partners, employees, agents, consultants and subcontractors of each and any of them, for all losses and damages caused by, arising out of, or resulting from fire or any of the perils, risks, or causes of loss covered by such policies.
- C. The waivers in this Paragraph 6.05 include the waiver of rights due to business interruption, loss of use, or other consequential loss extending beyond direct physical loss or damage to Owner's property or the Work caused by, arising out of, or resulting from fire or other insured peril, risk, or cause of loss.
- D. Contractor shall be responsible for assuring that each Subcontract contains provisions whereby the Subcontractor waives all rights against Owner, Contractor, all individuals or entities identified in the Supplementary Conditions as insureds, the Engineer and its consultants, and the officers, directors, members, partners, employees, agents, consultants, and subcontractors of each and any of them, for all losses and damages caused by, arising out of, relating to, or resulting from fire or other peril, risk, or cause of loss covered by builder's risk insurance, installation floater, and any other property insurance applicable to the Work.

6.06 *Receipt and Application of Property Insurance Proceeds*

- A. Any insured loss under the builder's risk and other policies of property insurance required by Paragraph 6.04 will be adjusted and settled with the named insured that purchased the policy. Such named insured shall act as fiduciary for the other insureds, and give notice to such other insureds that adjustment and settlement of a claim is in progress. Any other insured may state its position regarding a claim for insured loss in writing within 15 days after notice of such claim.
- B. Proceeds for such insured losses may be made payable by the insurer either jointly to multiple insureds, or to the named insured that purchased the policy in its own right and as fiduciary for other insureds, subject to the requirements of any applicable mortgage clause. A named insured receiving insurance proceeds under the builder's risk and other policies of insurance required by Paragraph 6.04 shall maintain such proceeds in a segregated account, and distribute such proceeds in accordance with such agreement as the parties in interest may reach, or as otherwise required under the dispute resolution provisions of this Contract or applicable Laws and Regulations.
- C. If no other special agreement is reached, Contractor shall repair or replace the damaged Work, using allocated insurance proceeds.

ARTICLE 7—CONTRACTOR'S RESPONSIBILITIES

7.01 *Contractor's Means and Methods of Construction*

- A. Contractor shall be solely responsible for the means, methods, techniques, sequences, and procedures of construction.
- B. If the Contract Documents note, or Contractor determines, that professional engineering or other design services are needed to carry out Contractor's responsibilities for construction means, methods, techniques, sequences, and procedures, or for Site safety, then Contractor shall cause such services to be provided by a properly licensed design professional, at Contractor's expense. Such services are not Owner-delegated professional design services under this Contract, and neither Owner nor Engineer has any responsibility with respect to (1) Contractor's determination of the need for such services, (2) the qualifications or licensing of the design professionals retained or employed by Contractor, (3) the performance of such services, or (4) any errors, omissions, or defects in such services.

7.02 *Supervision and Superintendence*

- A. Contractor shall supervise, inspect, and direct the Work competently and efficiently, devoting such attention thereto and applying such skills and expertise as may be necessary to perform the Work in accordance with the Contract Documents.
- B. At all times during the progress of the Work, Contractor shall assign a competent resident superintendent who will not be replaced without written notice to Owner and Engineer except under extraordinary circumstances.

7.03 *Labor; Working Hours*

- A. Contractor shall provide competent, suitably qualified personnel to survey and lay out the Work and perform construction as required by the Contract Documents. Contractor shall maintain good discipline and order at the Site.

- B. Contractor shall be fully responsible to Owner and Engineer for all acts and omissions of Contractor's employees; of Suppliers and Subcontractors, and their employees; and of any other individuals or entities performing or furnishing any of the Work, just as Contractor is responsible for Contractor's own acts and omissions.
- C. Except as otherwise required for the safety or protection of persons or the Work or property at the Site or adjacent thereto, and except as otherwise stated in the Contract Documents, all Work at the Site will be performed during regular working hours, Monday through Friday. Contractor will not perform Work on a Saturday, Sunday, or any legal holiday. Contractor may perform Work outside regular working hours or on Saturdays, Sundays, or legal holidays only with Owner's written consent, which will not be unreasonably withheld.

7.04 *Services, Materials, and Equipment*

- A. Unless otherwise specified in the Contract Documents, Contractor shall provide and assume full responsibility for all services, materials, equipment, labor, transportation, construction equipment and machinery, tools, appliances, fuel, power, light, heat, telephone, water, sanitary facilities, temporary facilities, and all other facilities and incidentals necessary for the performance, testing, start up, and completion of the Work, whether or not such items are specifically called for in the Contract Documents.
- B. All materials and equipment incorporated into the Work must be new and of good quality, except as otherwise provided in the Contract Documents. All special warranties and guarantees required by the Specifications will expressly run to the benefit of Owner. If required by Engineer, Contractor shall furnish satisfactory evidence (including reports of required tests) as to the source, kind, and quality of materials and equipment.
- C. All materials and equipment must be stored, applied, installed, connected, erected, protected, used, cleaned, and conditioned in accordance with instructions of the applicable Supplier, except as otherwise may be provided in the Contract Documents.

7.05 *"Or Equals"*

- A. *Contractor's Request; Governing Criteria:* Whenever an item of equipment or material is specified or described in the Contract Documents by using the names of one or more proprietary items or specific Suppliers, the Contract Price has been based upon Contractor furnishing such item as specified. The specification or description of such an item is intended to establish the type, function, appearance, and quality required. Unless the specification or description contains or is followed by words reading that no like, equivalent, or "or equal" item is permitted, Contractor may request that Engineer authorize the use of other items of equipment or material, or items from other proposed Suppliers, under the circumstances described below.
 - 1. If Engineer in its sole discretion determines that an item of equipment or material proposed by Contractor is functionally equal to that named and sufficiently similar so that no change in related Work will be required, Engineer will deem it an "or equal" item. For the purposes of this paragraph, a proposed item of equipment or material will be considered functionally equal to an item so named if:
 - a. in the exercise of reasonable judgment Engineer determines that the proposed item:
 - 1) is at least equal in materials of construction, quality, durability, appearance, strength, and design characteristics;

- 2) will reliably perform at least equally well the function and achieve the results imposed by the design concept of the completed Project as a functioning whole;
 - 3) has a proven record of performance and availability of responsive service; and
 - 4) is not objectionable to Owner.
- b. Contractor certifies that, if the proposed item is approved and incorporated into the Work:
- 1) there will be no increase in cost to the Owner or increase in Contract Times; and
 - 2) the item will conform substantially to the detailed requirements of the item named in the Contract Documents.
- B. *Contractor's Expense:* Contractor shall provide all data in support of any proposed "or equal" item at Contractor's expense.
- C. *Engineer's Evaluation and Determination:* Engineer will be allowed a reasonable time to evaluate each "or-equal" request. Engineer may require Contractor to furnish additional data about the proposed "or-equal" item. Engineer will be the sole judge of acceptability. No "or-equal" item will be ordered, furnished, installed, or utilized until Engineer's review is complete and Engineer determines that the proposed item is an "or-equal," which will be evidenced by an approved Shop Drawing or other written communication. Engineer will advise Contractor in writing of any negative determination.
- D. *Effect of Engineer's Determination:* Neither approval nor denial of an "or-equal" request will result in any change in Contract Price. The Engineer's denial of an "or-equal" request will be final and binding, and may not be reversed through an appeal under any provision of the Contract.
- E. *Treatment as a Substitution Request:* If Engineer determines that an item of equipment or material proposed by Contractor does not qualify as an "or-equal" item, Contractor may request that Engineer consider the item a proposed substitute pursuant to Paragraph 7.06.

7.06 *Substitutes*

- A. *Contractor's Request; Governing Criteria:* Unless the specification or description of an item of equipment or material required to be furnished under the Contract Documents contains or is followed by words reading that no substitution is permitted, Contractor may request that Engineer authorize the use of other items of equipment or material under the circumstances described below. To the extent possible such requests must be made before commencement of related construction at the Site.
1. Contractor shall submit sufficient information as provided below to allow Engineer to determine if the item of material or equipment proposed is functionally equivalent to that named and an acceptable substitute therefor. Engineer will not accept requests for review of proposed substitute items of equipment or material from anyone other than Contractor.
 2. The requirements for review by Engineer will be as set forth in Paragraph 7.06.B, as supplemented by the Specifications, and as Engineer may decide is appropriate under the circumstances.

3. Contractor shall make written application to Engineer for review of a proposed substitute item of equipment or material that Contractor seeks to furnish or use. The application:
 - a. will certify that the proposed substitute item will:
 - 1) perform adequately the functions and achieve the results called for by the general design;
 - 2) be similar in substance to the item specified; and
 - 3) be suited to the same use as the item specified.
 - b. will state:
 - 1) the extent, if any, to which the use of the proposed substitute item will necessitate a change in Contract Times;
 - 2) whether use of the proposed substitute item in the Work will require a change in any of the Contract Documents (or in the provisions of any other direct contract with Owner for other work on the Project) to adapt the design to the proposed substitute item; and
 - 3) whether incorporation or use of the proposed substitute item in connection with the Work is subject to payment of any license fee or royalty.
 - c. will identify:
 - 1) all variations of the proposed substitute item from the item specified; and
 - 2) available engineering, sales, maintenance, repair, and replacement services.
 - d. will contain an itemized estimate of all costs or credits that will result directly or indirectly from use of such substitute item, including but not limited to changes in Contract Price, shared savings, costs of redesign, and claims of other contractors affected by any resulting change.
- B. *Engineer's Evaluation and Determination*: Engineer will be allowed a reasonable time to evaluate each substitute request, and to obtain comments and direction from Owner. Engineer may require Contractor to furnish additional data about the proposed substitute item. Engineer will be the sole judge of acceptability. No substitute will be ordered, furnished, installed, or utilized until Engineer's review is complete and Engineer determines that the proposed item is an acceptable substitute. Engineer's determination will be evidenced by a Field Order or a proposed Change Order accounting for the substitution itself and all related impacts, including changes in Contract Price or Contract Times. Engineer will advise Contractor in writing of any negative determination.
- C. *Special Guarantee*: Owner may require Contractor to furnish at Contractor's expense a special performance guarantee or other surety with respect to any substitute.
- D. *Reimbursement of Engineer's Cost*: Engineer will record Engineer's costs in evaluating a substitute proposed or submitted by Contractor. Whether or not Engineer approves a substitute so proposed or submitted by Contractor, Contractor shall reimburse Owner for the reasonable charges of Engineer for evaluating each such proposed substitute. Contractor shall also reimburse Owner for the reasonable charges of Engineer for making changes in the Contract Documents (or in the provisions of any other direct contract with Owner) resulting from the acceptance of each proposed substitute.

- E. *Contractor's Expense*: Contractor shall provide all data in support of any proposed substitute at Contractor's expense.
- F. *Effect of Engineer's Determination*: If Engineer approves the substitution request, Contractor shall execute the proposed Change Order and proceed with the substitution. The Engineer's denial of a substitution request will be final and binding, and may not be reversed through an appeal under any provision of the Contract. Contractor may challenge the scope of reimbursement costs imposed under Paragraph 7.06.D, by timely submittal of a Change Proposal.

7.07 *Concerning Subcontractors and Suppliers*

- A. Contractor may retain Subcontractors and Suppliers for the performance of parts of the Work. Such Subcontractors and Suppliers must be acceptable to Owner. The Contractor's retention of a Subcontractor or Supplier for the performance of parts of the Work will not relieve Contractor's obligation to Owner to perform and complete the Work in accordance with the Contract Documents.
- B. Contractor shall retain specific Subcontractors and Suppliers for the performance of designated parts of the Work if required by the Contract to do so.
- C. Subsequent to the submittal of Contractor's Bid or final negotiation of the terms of the Contract, Owner may not require Contractor to retain any Subcontractor or Supplier to furnish or perform any of the Work against which Contractor has reasonable objection.
- D. Prior to entry into any binding subcontract or purchase order, Contractor shall submit to Owner the identity of the proposed Subcontractor or Supplier (unless Owner has already deemed such proposed Subcontractor or Supplier acceptable during the bidding process or otherwise). Such proposed Subcontractor or Supplier shall be deemed acceptable to Owner unless Owner raises a substantive, reasonable objection within 5 days.
- E. Owner may require the replacement of any Subcontractor or Supplier. Owner also may require Contractor to retain specific replacements; provided, however, that Owner may not require a replacement to which Contractor has a reasonable objection. If Contractor has submitted the identity of certain Subcontractors or Suppliers for acceptance by Owner, and Owner has accepted it (either in writing or by failing to make written objection thereto), then Owner may subsequently revoke the acceptance of any such Subcontractor or Supplier so identified solely on the basis of substantive, reasonable objection after due investigation. Contractor shall submit an acceptable replacement for the rejected Subcontractor or Supplier.
- F. If Owner requires the replacement of any Subcontractor or Supplier retained by Contractor to perform any part of the Work, then Contractor shall be entitled to an adjustment in Contract Price or Contract Times, with respect to the replacement; and Contractor shall initiate a Change Proposal for such adjustment within 30 days of Owner's requirement of replacement.
- G. No acceptance by Owner of any such Subcontractor or Supplier, whether initially or as a replacement, will constitute a waiver of the right of Owner to the completion of the Work in accordance with the Contract Documents.

- H. On a monthly basis, Contractor shall submit to Engineer a complete list of all Subcontractors and Suppliers having a direct contract with Contractor, and of all other Subcontractors and Suppliers known to Contractor at the time of submittal.
- I. Contractor shall be solely responsible for scheduling and coordinating the work of Subcontractors and Suppliers.
- J. The divisions and sections of the Specifications and the identifications of any Drawings do not control Contractor in dividing the Work among Subcontractors or Suppliers, or in delineating the Work to be performed by any specific trade.
- K. All Work performed for Contractor by a Subcontractor or Supplier must be pursuant to an appropriate contractual agreement that specifically binds the Subcontractor or Supplier to the applicable terms and conditions of the Contract for the benefit of Owner and Engineer.
- L. Owner may furnish to any Subcontractor or Supplier, to the extent practicable, information about amounts paid to Contractor for Work performed for Contractor by the Subcontractor or Supplier.
- M. Contractor shall restrict all Subcontractors and Suppliers from communicating with Engineer or Owner, except through Contractor or in case of an emergency, or as otherwise expressly allowed in this Contract.

7.08 *Patent Fees and Royalties*

- A. Contractor shall pay all license fees and royalties and assume all costs incident to the use in the performance of the Work or the incorporation in the Work of any invention, design, process, product, or device which is the subject of patent rights or copyrights held by others. If an invention, design, process, product, or device is specified in the Contract Documents for use in the performance of the Work and if, to the actual knowledge of Owner or Engineer, its use is subject to patent rights or copyrights calling for the payment of any license fee or royalty to others, the existence of such rights will be disclosed in the Contract Documents.
- B. To the fullest extent permitted by Laws and Regulations, Owner shall indemnify and hold harmless Contractor, and its officers, directors, members, partners, employees, agents, consultants, and subcontractors, from and against all claims, costs, losses, and damages (including but not limited to all fees and charges of engineers, architects, attorneys, and other professionals, and all court or arbitration or other dispute resolution costs) arising out of or relating to any infringement of patent rights or copyrights incident to the use in the performance of the Work or resulting from the incorporation in the Work of any invention, design, process, product, or device specified in the Contract Documents, but not identified as being subject to payment of any license fee or royalty to others required by patent rights or copyrights.
- C. To the fullest extent permitted by Laws and Regulations, Contractor shall indemnify and hold harmless Owner and Engineer, and the officers, directors, members, partners, employees, agents, consultants and subcontractors of each and any of them, from and against all claims, costs, losses, and damages (including but not limited to all fees and charges of engineers, architects, attorneys, and other professionals and all court or arbitration or other dispute resolution costs) arising out of or relating to any infringement of patent rights or copyrights incident to the use in the performance of the Work or resulting from the incorporation in the Work of any invention, design, process, product, or device not specified in the Contract Documents.

7.09 *Permits*

- A. Unless otherwise provided in the Contract Documents, Contractor shall obtain and pay for all construction permits, licenses, and certificates of occupancy. Owner shall assist Contractor, when necessary, in obtaining such permits and licenses. Contractor shall pay all governmental charges and inspection fees necessary for the prosecution of the Work which are applicable at the time of the submission of Contractor's Bid (or when Contractor became bound under a negotiated contract). Owner shall pay all charges of utility owners for connections for providing permanent service to the Work.

7.10 *Taxes*

- A. Contractor shall pay all sales, consumer, use, and other similar taxes required to be paid by Contractor in accordance with the Laws and Regulations of the place of the Project which are applicable during the performance of the Work.

7.11 *Laws and Regulations*

- A. Contractor shall give all notices required by and shall comply with all Laws and Regulations applicable to the performance of the Work. Neither Owner nor Engineer shall be responsible for monitoring Contractor's compliance with any Laws or Regulations.
- B. If Contractor performs any Work or takes any other action knowing or having reason to know that it is contrary to Laws or Regulations, Contractor shall bear all resulting costs and losses, and shall indemnify and hold harmless Owner and Engineer, and the officers, directors, members, partners, employees, agents, consultants, and subcontractors of each and any of them, from and against all claims, costs, losses, and damages (including but not limited to all fees and charges of engineers, architects, attorneys, and other professionals and all court or arbitration or other dispute resolution costs) arising out of or relating to such Work or other action. It is not Contractor's responsibility to make certain that the Work described in the Contract Documents is in accordance with Laws and Regulations, but this does not relieve Contractor of its obligations under Paragraph 3.03.
- C. Owner or Contractor may give written notice to the other party of any changes after the submission of Contractor's Bid (or after the date when Contractor became bound under a negotiated contract) in Laws or Regulations having an effect on the cost or time of performance of the Work, including but not limited to changes in Laws or Regulations having an effect on procuring permits and on sales, use, value-added, consumption, and other similar taxes. If Owner and Contractor are unable to agree on entitlement to or on the amount or extent, if any, of any adjustment in Contract Price or Contract Times resulting from such changes, then within 30 days of such written notice Contractor may submit a Change Proposal, or Owner may initiate a Claim.

7.12 *Record Documents*

- A. Contractor shall maintain in a safe place at the Site one printed record copy of all Drawings, Specifications, Addenda, Change Orders, Work Change Directives, Field Orders, written interpretations and clarifications, and approved Shop Drawings. Contractor shall keep such record documents in good order and annotate them to show changes made during construction. These record documents, together with all approved Samples, will be available to Engineer for reference. Upon completion of the Work, Contractor shall deliver these record documents to Engineer.

7.13 *Safety and Protection*

- A. Contractor shall be solely responsible for initiating, maintaining, and supervising all safety precautions and programs in connection with the Work. Such responsibility does not relieve Subcontractors of their responsibility for the safety of persons or property in the performance of their work, nor for compliance with applicable safety Laws and Regulations.
- B. Contractor shall designate a qualified and experienced safety representative whose duties and responsibilities are the prevention of Work-related accidents and the maintenance and supervision of safety precautions and programs.
- C. Contractor shall take all necessary precautions for the safety of, and shall provide the necessary protection to prevent damage, injury, or loss to:
 - 1. all persons on the Site or who may be affected by the Work;
 - 2. all the Work and materials and equipment to be incorporated therein, whether in storage on or off the Site; and
 - 3. other property at the Site or adjacent thereto, including trees, shrubs, lawns, walks, pavements, roadways, structures, other work in progress, utilities, and Underground Facilities not designated for removal, relocation, or replacement in the course of construction.
- D. All damage, injury, or loss to any property referred to in Paragraph 7.13.C.2 or 7.13.C.3 caused, directly or indirectly, in whole or in part, by Contractor, any Subcontractor, Supplier, or any other individual or entity directly or indirectly employed by any of them to perform any of the Work, or anyone for whose acts any of them may be liable, shall be remedied by Contractor at its expense (except damage or loss attributable to the fault of Drawings or Specifications or to the acts or omissions of Owner or Engineer or anyone employed by any of them, or anyone for whose acts any of them may be liable, and not attributable, directly or indirectly, in whole or in part, to the fault or negligence of Contractor or any Subcontractor, Supplier, or other individual or entity directly or indirectly employed by any of them).
- E. Contractor shall comply with all applicable Laws and Regulations relating to the safety of persons or property, or to the protection of persons or property from damage, injury, or loss; and shall erect and maintain all necessary safeguards for such safety and protection.
- F. Contractor shall notify Owner; the owners of adjacent property; the owners of Underground Facilities and other utilities (if the identity of such owners is known to Contractor); and other contractors and utility owners performing work at or adjacent to the Site, in writing, when Contractor knows that prosecution of the Work may affect them, and shall cooperate with them in the protection, removal, relocation, and replacement of their property or work in progress.
- G. Contractor shall comply with the applicable requirements of Owner's safety programs, if any. Any Owner's safety programs that are applicable to the Work are identified or included in the Supplementary Conditions or Specifications.
- H. Contractor shall inform Owner and Engineer of the specific requirements of Contractor's safety program with which Owner's and Engineer's employees and representatives must comply while at the Site.

- I. Contractor's duties and responsibilities for safety and protection will continue until all the Work is completed, Engineer has issued a written notice to Owner and Contractor in accordance with Paragraph 15.06.C that the Work is acceptable, and Contractor has left the Site (except as otherwise expressly provided in connection with Substantial Completion).
- J. Contractor's duties and responsibilities for safety and protection will resume whenever Contractor or any Subcontractor or Supplier returns to the Site to fulfill warranty or correction obligations, or to conduct other tasks arising from the Contract Documents.

7.14 *Hazard Communication Programs*

- A. Contractor shall be responsible for coordinating any exchange of safety data sheets (formerly known as material safety data sheets) or other hazard communication information required to be made available to or exchanged between or among employers at the Site in accordance with Laws or Regulations.

7.15 *Emergencies*

- A. In emergencies affecting the safety or protection of persons or the Work or property at the Site or adjacent thereto, Contractor is obligated to act to prevent damage, injury, or loss. Contractor shall give Engineer prompt written notice if Contractor believes that any significant changes in the Work or variations from the Contract Documents have been caused by an emergency, or are required as a result of Contractor's response to an emergency. If Engineer determines that a change in the Contract Documents is required because of an emergency or Contractor's response, a Work Change Directive or Change Order will be issued.

7.16 *Submittals*

A. *Shop Drawing and Sample Requirements*

- 1. Before submitting a Shop Drawing or Sample, Contractor shall:
 - a. review and coordinate the Shop Drawing or Sample with other Shop Drawings and Samples and with the requirements of the Work and the Contract Documents;
 - b. determine and verify:
 - 1) all field measurements, quantities, dimensions, specified performance and design criteria, installation requirements, materials, catalog numbers, and similar information with respect to the Submittal;
 - 2) the suitability of all materials and equipment offered with respect to the indicated application, fabrication, shipping, handling, storage, assembly, and installation pertaining to the performance of the Work; and
 - 3) all information relative to Contractor's responsibilities for means, methods, techniques, sequences, and procedures of construction, and safety precautions and programs incident thereto;
 - c. confirm that the Submittal is complete with respect to all related data included in the Submittal.
- 2. Each Shop Drawing or Sample must bear a stamp or specific written certification that Contractor has satisfied Contractor's obligations under the Contract Documents with respect to Contractor's review of that Submittal, and that Contractor approves the Submittal.

3. With each Shop Drawing or Sample, Contractor shall give Engineer specific written notice of any variations that the Submittal may have from the requirements of the Contract Documents. This notice must be set forth in a written communication separate from the Submittal; and, in addition, in the case of a Shop Drawing by a specific notation made on the Shop Drawing itself.
- B. *Submittal Procedures for Shop Drawings and Samples:* Contractor shall label and submit Shop Drawings and Samples to Engineer for review and approval in accordance with the accepted Schedule of Submittals.
1. *Shop Drawings*
 - a. Contractor shall submit the number of copies required in the Specifications.
 - b. Data shown on the Shop Drawings must be complete with respect to quantities, dimensions, specified performance and design criteria, materials, and similar data to show Engineer the services, materials, and equipment Contractor proposes to provide, and to enable Engineer to review the information for the limited purposes required by Paragraph 7.16.C.
 2. *Samples*
 - a. Contractor shall submit the number of Samples required in the Specifications.
 - b. Contractor shall clearly identify each Sample as to material, Supplier, pertinent data such as catalog numbers, the use for which intended and other data as Engineer may require to enable Engineer to review the Submittal for the limited purposes required by Paragraph 7.16.C.
 3. Where a Shop Drawing or Sample is required by the Contract Documents or the Schedule of Submittals, any related Work performed prior to Engineer's review and approval of the pertinent submittal will be at the sole expense and responsibility of Contractor.
- C. *Engineer's Review of Shop Drawings and Samples*
1. Engineer will provide timely review of Shop Drawings and Samples in accordance with the accepted Schedule of Submittals. Engineer's review and approval will be only to determine if the items covered by the Submittals will, after installation or incorporation in the Work, comply with the requirements of the Contract Documents, and be compatible with the design concept of the completed Project as a functioning whole as indicated by the Contract Documents.
 2. Engineer's review and approval will not extend to means, methods, techniques, sequences, or procedures of construction, or to safety precautions or programs incident thereto.
 3. Engineer's review and approval of a separate item as such will not indicate approval of the assembly in which the item functions.
 4. Engineer's review and approval of a Shop Drawing or Sample will not relieve Contractor from responsibility for any variation from the requirements of the Contract Documents unless Contractor has complied with the requirements of Paragraph 7.16.A.3 and Engineer has given written approval of each such variation by specific written notation thereof incorporated in or accompanying the Shop Drawing or Sample. Engineer will

document any such approved variation from the requirements of the Contract Documents in a Field Order or other appropriate Contract modification.

5. Engineer's review and approval of a Shop Drawing or Sample will not relieve Contractor from responsibility for complying with the requirements of Paragraphs 7.16.A and B.
6. Engineer's review and approval of a Shop Drawing or Sample, or of a variation from the requirements of the Contract Documents, will not, under any circumstances, change the Contract Times or Contract Price, unless such changes are included in a Change Order.
7. Neither Engineer's receipt, review, acceptance, or approval of a Shop Drawing or Sample will result in such item becoming a Contract Document.
8. Contractor shall perform the Work in compliance with the requirements and commitments set forth in approved Shop Drawings and Samples, subject to the provisions of Paragraph 7.16.C.4.

D. Resubmittal Procedures for Shop Drawings and Samples

1. Contractor shall make corrections required by Engineer and shall return the required number of corrected copies of Shop Drawings and submit, as required, new Samples for review and approval. Contractor shall direct specific attention in writing to revisions other than the corrections called for by Engineer on previous Submittals.
2. Contractor shall furnish required Shop Drawing and Sample submittals with sufficient information and accuracy to obtain required approval of an item with no more than two resubmittals. Engineer will record Engineer's time for reviewing a third or subsequent resubmittal of a Shop Drawing or Sample, and Contractor shall be responsible for Engineer's charges to Owner for such time. Owner may impose a set-off against payments due Contractor to secure reimbursement for such charges.
3. If Contractor requests a change of a previously approved Shop Drawing or Sample, Contractor shall be responsible for Engineer's charges to Owner for its review time, and Owner may impose a set-off against payments due Contractor to secure reimbursement for such charges, unless the need for such change is beyond the control of Contractor.

E. Submittals Other than Shop Drawings, Samples, and Owner-Delegated Designs

1. The following provisions apply to all Submittals other than Shop Drawings, Samples, and Owner-delegated designs:
 - a. Contractor shall submit all such Submittals to the Engineer in accordance with the Schedule of Submittals and pursuant to the applicable terms of the Contract Documents.
 - b. Engineer will provide timely review of all such Submittals in accordance with the Schedule of Submittals and return such Submittals with a notation of either Accepted or Not Accepted. Any such Submittal that is not returned within the time established in the Schedule of Submittals will be deemed accepted.
 - c. Engineer's review will be only to determine if the Submittal is acceptable under the requirements of the Contract Documents as to general form and content of the Submittal.

- d. If any such Submittal is not accepted, Contractor shall confer with Engineer regarding the reason for the non-acceptance, and resubmit an acceptable document.
 2. Procedures for the submittal and acceptance of the Progress Schedule, the Schedule of Submittals, and the Schedule of Values are set forth in Paragraphs 2.03, 2.04, and 2.05.
- F. Owner-delegated Designs: Submittals pursuant to Owner-delegated designs are governed by the provisions of Paragraph 7.19.

7.17 Contractor's General Warranty and Guarantee

- A. Contractor warrants and guarantees to Owner that all Work will be in accordance with the Contract Documents and will not be defective. Engineer is entitled to rely on Contractor's warranty and guarantee.
- B. Owner's rights under this warranty and guarantee are in addition to, and are not limited by, Owner's rights under the correction period provisions of Paragraph 15.08. The time in which Owner may enforce its warranty and guarantee rights under this Paragraph 7.17 is limited only by applicable Laws and Regulations restricting actions to enforce such rights; provided, however, that after the end of the correction period under Paragraph 15.08:
1. Owner shall give Contractor written notice of any defective Work within 60 days of the discovery that such Work is defective; and
 2. Such notice will be deemed the start of an event giving rise to a Claim under Paragraph 12.01.B, such that any related Claim must be brought within 30 days of the notice.
- C. Contractor's warranty and guarantee hereunder excludes defects or damage caused by:
1. abuse, or improper modification, maintenance, or operation, by persons other than Contractor, Subcontractors, Suppliers, or any other individual or entity for whom Contractor is responsible; or
 2. normal wear and tear under normal usage.
- D. Contractor's obligation to perform and complete the Work in accordance with the Contract Documents is absolute. None of the following will constitute an acceptance of Work that is not in accordance with the Contract Documents, a release of Contractor's obligation to perform the Work in accordance with the Contract Documents, or a release of Owner's warranty and guarantee rights under this Paragraph 7.17:
1. Observations by Engineer;
 2. Recommendation by Engineer or payment by Owner of any progress or final payment;
 3. The issuance of a certificate of Substantial Completion by Engineer or any payment related thereto by Owner;
 4. Use or occupancy of the Work or any part thereof by Owner;
 5. Any review and approval of a Shop Drawing or Sample submittal;
 6. The issuance of a notice of acceptability by Engineer;
 7. The end of the correction period established in Paragraph 15.08;
 8. Any inspection, test, or approval by others; or

9. Any correction of defective Work by Owner.
- E. If the Contract requires the Contractor to accept the assignment of a contract entered into by Owner, then the specific warranties, guarantees, and correction obligations contained in the assigned contract will govern with respect to Contractor's performance obligations to Owner for the Work described in the assigned contract.

7.18 *Indemnification*

- A. To the fullest extent permitted by Laws and Regulations, and in addition to any other obligations of Contractor under the Contract or otherwise, Contractor shall indemnify and hold harmless Owner and Engineer, and the officers, directors, members, partners, employees, agents, consultants and subcontractors of each and any of them, from losses, damages, costs, and judgments (including but not limited to all fees and charges of engineers, architects, attorneys, and other professionals, and all court or arbitration or other dispute resolution costs) arising from third-party claims or actions relating to or resulting from the performance or furnishing of the Work, provided that any such claim, action, loss, cost, judgment or damage is attributable to bodily injury, sickness, disease, or death, or to damage to or destruction of tangible property (other than the Work itself), including the loss of use resulting therefrom, but only to the extent caused by any negligent act or omission of Contractor, any Subcontractor, any Supplier, or any individual or entity directly or indirectly employed by any of them to perform any of the Work, or anyone for whose acts any of them may be liable.
- B. In any and all claims against Owner or Engineer, or any of their officers, directors, members, partners, employees, agents, consultants, or subcontractors, by any employee (or the survivor or personal representative of such employee) of Contractor, any Subcontractor, any Supplier, or any individual or entity directly or indirectly employed by any of them to perform any of the Work, or anyone for whose acts any of them may be liable, the indemnification obligation under Paragraph 7.18.A will not be limited in any way by any limitation on the amount or type of damages, compensation, or benefits payable by or for Contractor or any such Subcontractor, Supplier, or other individual or entity under workers' compensation acts, disability benefit acts, or other employee benefit acts.

7.19 *Delegation of Professional Design Services*

- A. Owner may require Contractor to provide professional design services for a portion of the Work by express delegation in the Contract Documents. Such delegation will specify the performance and design criteria that such services must satisfy, and the Submittals that Contractor must furnish to Engineer with respect to the Owner-delegated design.
- B. Contractor shall cause such Owner-delegated professional design services to be provided pursuant to the professional standard of care by a properly licensed design professional, whose signature and seal must appear on all drawings, calculations, specifications, certifications, and Submittals prepared by such design professional. Such design professional must issue all certifications of design required by Laws and Regulations.
- C. If a Shop Drawing or other Submittal related to the Owner-delegated design is prepared by Contractor, a Subcontractor, or others for submittal to Engineer, then such Shop Drawing or other Submittal must bear the written approval of Contractor's design professional when submitted by Contractor to Engineer.

- D. Owner and Engineer shall be entitled to rely upon the adequacy, accuracy, and completeness of the services, certifications, and approvals performed or provided by the design professionals retained or employed by Contractor under an Owner-delegated design, subject to the professional standard of care and the performance and design criteria stated in the Contract Documents.
- E. Pursuant to this Paragraph 7.19, Engineer's review, approval, and other determinations regarding design drawings, calculations, specifications, certifications, and other Submittals furnished by Contractor pursuant to an Owner-delegated design will be only for the following limited purposes:
 - 1. Checking for conformance with the requirements of this Paragraph 7.19;
 - 2. Confirming that Contractor (through its design professionals) has used the performance and design criteria specified in the Contract Documents; and
 - 3. Establishing that the design furnished by Contractor is consistent with the design concept expressed in the Contract Documents.
- F. Contractor shall not be responsible for the adequacy of performance or design criteria specified by Owner or Engineer.
- G. Contractor is not required to provide professional services in violation of applicable Laws and Regulations.

ARTICLE 8—OTHER WORK AT THE SITE

8.01 *Other Work*

- A. In addition to and apart from the Work under the Contract Documents, the Owner may perform other work at or adjacent to the Site. Such other work may be performed by Owner's employees, or through contracts between the Owner and third parties. Owner may also arrange to have third-party utility owners perform work on their utilities and facilities at or adjacent to the Site.
- B. If Owner performs other work at or adjacent to the Site with Owner's employees, or through contracts for such other work, then Owner shall give Contractor written notice thereof prior to starting any such other work. If Owner has advance information regarding the start of any third-party utility work that Owner has arranged to take place at or adjacent to the Site, Owner shall provide such information to Contractor.
- C. Contractor shall afford proper and safe access to the Site to each contractor that performs such other work, each utility owner performing other work, and Owner, if Owner is performing other work with Owner's employees, and provide a reasonable opportunity for the introduction and storage of materials and equipment and the execution of such other work.
- D. Contractor shall do all cutting, fitting, and patching of the Work that may be required to properly connect or otherwise make its several parts come together and properly integrate with such other work. Contractor shall not endanger any work of others by cutting, excavating, or otherwise altering such work; provided, however, that Contractor may cut or alter others' work with the written consent of Engineer and the others whose work will be affected.

- E. If the proper execution or results of any part of Contractor's Work depends upon work performed by others, Contractor shall inspect such other work and promptly report to Engineer in writing any delays, defects, or deficiencies in such other work that render it unavailable or unsuitable for the proper execution and results of Contractor's Work. Contractor's failure to so report will constitute an acceptance of such other work as fit and proper for integration with Contractor's Work except for latent defects and deficiencies in such other work.
- F. The provisions of this article are not applicable to work that is performed by third-party utilities or other third-party entities without a contract with Owner, or that is performed without having been arranged by Owner. If such work occurs, then any related delay, disruption, or interference incurred by Contractor is governed by the provisions of Paragraph 4.05.C.3.

8.02 *Coordination*

- A. If Owner intends to contract with others for the performance of other work at or adjacent to the Site, to perform other work at or adjacent to the Site with Owner's employees, or to arrange to have utility owners perform work at or adjacent to the Site, the following will be set forth in the Supplementary Conditions or provided to Contractor prior to the start of any such other work:
 - 1. The identity of the individual or entity that will have authority and responsibility for coordination of the activities among the various contractors;
 - 2. An itemization of the specific matters to be covered by such authority and responsibility; and
 - 3. The extent of such authority and responsibilities.
- B. Unless otherwise provided in the Supplementary Conditions, Owner shall have sole authority and responsibility for such coordination.

8.03 *Legal Relationships*

- A. If, in the course of performing other work for Owner at or adjacent to the Site, the Owner's employees, any other contractor working for Owner, or any utility owner that Owner has arranged to perform work, causes damage to the Work or to the property of Contractor or its Subcontractors, or delays, disrupts, interferes with, or increases the scope or cost of the performance of the Work, through actions or inaction, then Contractor shall be entitled to an equitable adjustment in the Contract Price or the Contract Times. Contractor must submit any Change Proposal seeking an equitable adjustment in the Contract Price or the Contract Times under this paragraph within 30 days of the damaging, delaying, disrupting, or interfering event. The entitlement to, and extent of, any such equitable adjustment will take into account information (if any) regarding such other work that was provided to Contractor in the Contract Documents prior to the submittal of the Bid or the final negotiation of the terms of the Contract, and any remedies available to Contractor under Laws or Regulations concerning utility action or inaction. When applicable, any such equitable adjustment in Contract Price will be conditioned on Contractor assigning to Owner all Contractor's rights against such other contractor or utility owner with respect to the damage, delay, disruption, or interference that is the subject of the adjustment. Contractor's entitlement to an adjustment of the Contract Times or Contract Price is subject to the provisions of Paragraphs 4.05.D and 4.05.E.

- B. Contractor shall take reasonable and customary measures to avoid damaging, delaying, disrupting, or interfering with the work of Owner, any other contractor, or any utility owner performing other work at or adjacent to the Site.
 - 1. If Contractor fails to take such measures and as a result damages, delays, disrupts, or interferes with the work of any such other contractor or utility owner, then Owner may impose a set-off against payments due Contractor, and assign to such other contractor or utility owner the Owner's contractual rights against Contractor with respect to the breach of the obligations set forth in this Paragraph 8.03.B.
 - 2. When Owner is performing other work at or adjacent to the Site with Owner's employees, Contractor shall be liable to Owner for damage to such other work, and for the reasonable direct delay, disruption, and interference costs incurred by Owner as a result of Contractor's failure to take reasonable and customary measures with respect to Owner's other work. In response to such damage, delay, disruption, or interference, Owner may impose a set-off against payments due Contractor.
- C. If Contractor damages, delays, disrupts, or interferes with the work of any other contractor, or any utility owner performing other work at or adjacent to the Site, through Contractor's failure to take reasonable and customary measures to avoid such impacts, or if any claim arising out of Contractor's actions, inactions, or negligence in performance of the Work at or adjacent to the Site is made by any such other contractor or utility owner against Contractor, Owner, or Engineer, then Contractor shall (1) promptly attempt to settle the claim as to all parties through negotiations with such other contractor or utility owner, or otherwise resolve the claim by arbitration or other dispute resolution proceeding or at law, and (2) indemnify and hold harmless Owner and Engineer, and the officers, directors, members, partners, employees, agents, consultants and subcontractors of each and any of them from and against any such claims, and against all costs, losses, and damages (including but not limited to all fees and charges of engineers, architects, attorneys, and other professionals and all court or arbitration or other dispute resolution costs) arising out of or relating to such damage, delay, disruption, or interference.

ARTICLE 9—OWNER'S RESPONSIBILITIES

9.01 *Communications to Contractor*

- A. Except as otherwise provided in these General Conditions, Owner shall issue all communications to Contractor through Engineer.

9.02 *Replacement of Engineer*

- A. Owner may at its discretion appoint an engineer to replace Engineer, provided Contractor makes no reasonable objection to the replacement engineer. The replacement engineer's status under the Contract Documents will be that of the former Engineer.

9.03 *Furnish Data*

- A. Owner shall promptly furnish the data required of Owner under the Contract Documents.

9.04 *Pay When Due*

- A. Owner shall make payments to Contractor when they are due as provided in the Agreement.

- 9.05 *Lands and Easements; Reports, Tests, and Drawings*
- A. Owner's duties with respect to providing lands and easements are set forth in Paragraph 5.01.
 - B. Owner's duties with respect to providing engineering surveys to establish reference points are set forth in Paragraph 4.03.
 - C. Article 5 refers to Owner's identifying and making available to Contractor copies of reports of explorations and tests of conditions at the Site, and drawings of physical conditions relating to existing surface or subsurface structures at the Site.
- 9.06 *Insurance*
- A. Owner's responsibilities, if any, with respect to purchasing and maintaining liability and property insurance are set forth in Article 6.
- 9.07 *Change Orders*
- A. Owner's responsibilities with respect to Change Orders are set forth in Article 11.
- 9.08 *Inspections, Tests, and Approvals*
- A. Owner's responsibility with respect to certain inspections, tests, and approvals is set forth in Paragraph 14.02.B.
- 9.09 *Limitations on Owner's Responsibilities*
- A. The Owner shall not supervise, direct, or have control or authority over, nor be responsible for, Contractor's means, methods, techniques, sequences, or procedures of construction, or the safety precautions and programs incident thereto, or for any failure of Contractor to comply with Laws and Regulations applicable to the performance of the Work. Owner will not be responsible for Contractor's failure to perform the Work in accordance with the Contract Documents.
- 9.10 *Undisclosed Hazardous Environmental Condition*
- A. Owner's responsibility in respect to an undisclosed Hazardous Environmental Condition is set forth in Paragraph 5.06.
- 9.11 *Evidence of Financial Arrangements*
- A. Upon request of Contractor, Owner shall furnish Contractor reasonable evidence that financial arrangements have been made to satisfy Owner's obligations under the Contract (including obligations under proposed changes in the Work).
- 9.12 *Safety Programs*
- A. While at the Site, Owner's employees and representatives shall comply with the specific applicable requirements of Contractor's safety programs of which Owner has been informed.
 - B. Owner shall furnish copies of any applicable Owner safety programs to Contractor.

ARTICLE 10—ENGINEER'S STATUS DURING CONSTRUCTION

10.01 *Owner's Representative*

- A. Engineer will be Owner's representative during the construction period. The duties and responsibilities and the limitations of authority of Engineer as Owner's representative during construction are set forth in the Contract.

10.02 *Visits to Site*

- A. Engineer will make visits to the Site at intervals appropriate to the various stages of construction as Engineer deems necessary in order to observe, as an experienced and qualified design professional, the progress that has been made and the quality of the various aspects of Contractor's executed Work. Based on information obtained during such visits and observations, Engineer, for the benefit of Owner, will determine, in general, if the Work is proceeding in accordance with the Contract Documents. Engineer will not be required to make exhaustive or continuous inspections on the Site to check the quality or quantity of the Work. Engineer's efforts will be directed toward providing for Owner a greater degree of confidence that the completed Work will conform generally to the Contract Documents. On the basis of such visits and observations, Engineer will keep Owner informed of the progress of the Work and will endeavor to guard Owner against defective Work.
- B. Engineer's visits and observations are subject to all the limitations on Engineer's authority and responsibility set forth in Paragraph 10.07. Particularly, but without limitation, during or as a result of Engineer's visits or observations of Contractor's Work, Engineer will not supervise, direct, control, or have authority over or be responsible for Contractor's means, methods, techniques, sequences, or procedures of construction, or the safety precautions and programs incident thereto, or for any failure of Contractor to comply with Laws and Regulations applicable to the performance of the Work.

10.03 *Resident Project Representative*

- A. If Owner and Engineer have agreed that Engineer will furnish a Resident Project Representative to represent Engineer at the Site and assist Engineer in observing the progress and quality of the Work, then the authority and responsibilities of any such Resident Project Representative will be as provided in the Supplementary Conditions, and limitations on the responsibilities thereof will be as provided in the Supplementary Conditions and in Paragraph 10.07.
- B. If Owner designates an individual or entity who is not Engineer's consultant, agent, or employee to represent Owner at the Site, then the responsibilities and authority of such individual or entity will be as provided in the Supplementary Conditions.

10.04 *Engineer's Authority*

- A. Engineer has the authority to reject Work in accordance with Article 14.
- B. Engineer's authority as to Submittals is set forth in Paragraph 7.16.
- C. Engineer's authority as to design drawings, calculations, specifications, certifications and other Submittals from Contractor in response to Owner's delegation (if any) to Contractor of professional design services, is set forth in Paragraph 7.19.
- D. Engineer's authority as to changes in the Work is set forth in Article 11.

E. Engineer's authority as to Applications for Payment is set forth in Article 15.

10.05 *Determinations for Unit Price Work*

A. Engineer will determine the actual quantities and classifications of Unit Price Work performed by Contractor as set forth in Paragraph 13.03.

10.06 *Decisions on Requirements of Contract Documents and Acceptability of Work*

A. Engineer will render decisions regarding the requirements of the Contract Documents, and judge the acceptability of the Work, pursuant to the specific procedures set forth herein for initial interpretations, Change Proposals, and acceptance of the Work. In rendering such decisions and judgments, Engineer will not show partiality to Owner or Contractor, and will not be liable to Owner, Contractor, or others in connection with any proceedings, interpretations, decisions, or judgments conducted or rendered in good faith.

10.07 *Limitations on Engineer's Authority and Responsibilities*

A. Neither Engineer's authority or responsibility under this Article 10 or under any other provision of the Contract, nor any decision made by Engineer in good faith either to exercise or not exercise such authority or responsibility or the undertaking, exercise, or performance of any authority or responsibility by Engineer, will create, impose, or give rise to any duty in contract, tort, or otherwise owed by Engineer to Contractor, any Subcontractor, any Supplier, any other individual or entity, or to any surety for or employee or agent of any of them.

B. Engineer will not supervise, direct, control, or have authority over or be responsible for Contractor's means, methods, techniques, sequences, or procedures of construction, or the safety precautions and programs incident thereto, or for any failure of Contractor to comply with Laws and Regulations applicable to the performance of the Work. Engineer will not be responsible for Contractor's failure to perform the Work in accordance with the Contract Documents.

C. Engineer will not be responsible for the acts or omissions of Contractor or of any Subcontractor, any Supplier, or of any other individual or entity performing any of the Work.

D. Engineer's review of the final Application for Payment and accompanying documentation, and all maintenance and operating instructions, schedules, guarantees, bonds, certificates of inspection, tests and approvals, and other documentation required to be delivered by Contractor under Paragraph 15.06.A, will only be to determine generally that their content complies with the requirements of, and in the case of certificates of inspections, tests, and approvals, that the results certified indicate compliance with the Contract Documents.

E. The limitations upon authority and responsibility set forth in this Paragraph 10.07 also apply to the Resident Project Representative, if any.

10.08 *Compliance with Safety Program*

A. While at the Site, Engineer's employees and representatives will comply with the specific applicable requirements of Owner's and Contractor's safety programs of which Engineer has been informed.

ARTICLE 11—CHANGES TO THE CONTRACT

11.01 *Amending and Supplementing the Contract*

- A. The Contract may be amended or supplemented by a Change Order, a Work Change Directive, or a Field Order.
- B. If an amendment or supplement to the Contract includes a change in the Contract Price or the Contract Times, such amendment or supplement must be set forth in a Change Order.
- C. All changes to the Contract that involve (1) the performance or acceptability of the Work, (2) the design (as set forth in the Drawings, Specifications, or otherwise), or (3) other engineering or technical matters, must be supported by Engineer's recommendation. Owner and Contractor may amend other terms and conditions of the Contract without the recommendation of the Engineer.

11.02 *Change Orders*

- A. Owner and Contractor shall execute appropriate Change Orders covering:
 - 1. Changes in Contract Price or Contract Times which are agreed to by the parties, including any undisputed sum or amount of time for Work actually performed in accordance with a Work Change Directive;
 - 2. Changes in Contract Price resulting from an Owner set-off, unless Contractor has duly contested such set-off;
 - 3. Changes in the Work which are: (a) ordered by Owner pursuant to Paragraph 11.05, (b) required because of Owner's acceptance of defective Work under Paragraph 14.04 or Owner's correction of defective Work under Paragraph 14.07, or (c) agreed to by the parties, subject to the need for Engineer's recommendation if the change in the Work involves the design (as set forth in the Drawings, Specifications, or otherwise) or other engineering or technical matters; and
 - 4. Changes that embody the substance of any final and binding results under: Paragraph 11.03.B, resolving the impact of a Work Change Directive; Paragraph 11.09, concerning Change Proposals; Article 12, Claims; Paragraph 13.02.D, final adjustments resulting from allowances; Paragraph 13.03.D, final adjustments relating to determination of quantities for Unit Price Work; and similar provisions.
- B. If Owner or Contractor refuses to execute a Change Order that is required to be executed under the terms of Paragraph 11.02.A, it will be deemed to be of full force and effect, as if fully executed.

11.03 *Work Change Directives*

- A. A Work Change Directive will not change the Contract Price or the Contract Times but is evidence that the parties expect that the modification ordered or documented by a Work Change Directive will be incorporated in a subsequently issued Change Order, following negotiations by the parties as to the Work Change Directive's effect, if any, on the Contract Price and Contract Times; or, if negotiations are unsuccessful, by a determination under the terms of the Contract Documents governing adjustments, expressly including Paragraph 11.07 regarding change of Contract Price.

- B. If Owner has issued a Work Change Directive and:
 - 1. Contractor believes that an adjustment in Contract Times or Contract Price is necessary, then Contractor shall submit any Change Proposal seeking such an adjustment no later than 30 days after the completion of the Work set out in the Work Change Directive.
 - 2. Owner believes that an adjustment in Contract Times or Contract Price is necessary, then Owner shall submit any Claim seeking such an adjustment no later than 60 days after issuance of the Work Change Directive.

11.04 *Field Orders*

- A. Engineer may authorize minor changes in the Work if the changes do not involve an adjustment in the Contract Price or the Contract Times and are compatible with the design concept of the completed Project as a functioning whole as indicated by the Contract Documents. Such changes will be accomplished by a Field Order and will be binding on Owner and also on Contractor, which shall perform the Work involved promptly.
- B. If Contractor believes that a Field Order justifies an adjustment in the Contract Price or Contract Times, then before proceeding with the Work at issue, Contractor shall submit a Change Proposal as provided herein.

11.05 *Owner-Authorized Changes in the Work*

- A. Without invalidating the Contract and without notice to any surety, Owner may, at any time or from time to time, order additions, deletions, or revisions in the Work. Changes involving the design (as set forth in the Drawings, Specifications, or otherwise) or other engineering or technical matters will be supported by Engineer's recommendation.
- B. Such changes in the Work may be accomplished by a Change Order, if Owner and Contractor have agreed as to the effect, if any, of the changes on Contract Times or Contract Price; or by a Work Change Directive. Upon receipt of any such document, Contractor shall promptly proceed with the Work involved; or, in the case of a deletion in the Work, promptly cease construction activities with respect to such deleted Work. Added or revised Work must be performed under the applicable conditions of the Contract Documents.
- C. Nothing in this Paragraph 11.05 obligates Contractor to undertake work that Contractor reasonably concludes cannot be performed in a manner consistent with Contractor's safety obligations under the Contract Documents or Laws and Regulations.

11.06 *Unauthorized Changes in the Work*

- A. Contractor shall not be entitled to an increase in the Contract Price or an extension of the Contract Times with respect to any work performed that is not required by the Contract Documents, as amended, modified, or supplemented, except in the case of an emergency as provided in Paragraph 7.15 or in the case of uncovering Work as provided in Paragraph 14.05.C.2.

11.07 *Change of Contract Price*

- A. The Contract Price may only be changed by a Change Order. Any Change Proposal for an adjustment in the Contract Price must comply with the provisions of Paragraph 11.09. Any Claim for an adjustment of Contract Price must comply with the provisions of Article 12.
- B. An adjustment in the Contract Price will be determined as follows:

1. Where the Work involved is covered by unit prices contained in the Contract Documents, then by application of such unit prices to the quantities of the items involved (subject to the provisions of Paragraph 13.03);
 2. Where the Work involved is not covered by unit prices contained in the Contract Documents, then by a mutually agreed lump sum (which may include an allowance for overhead and profit not necessarily in accordance with Paragraph 11.07.C.2); or
 3. Where the Work involved is not covered by unit prices contained in the Contract Documents and the parties do not reach mutual agreement to a lump sum, then on the basis of the Cost of the Work (determined as provided in Paragraph 13.01) plus a Contractor's fee for overhead and profit (determined as provided in Paragraph 11.07.C).
- C. *Contractor's Fee:* When applicable, the Contractor's fee for overhead and profit will be determined as follows:
1. A mutually acceptable fixed fee; or
 2. If a fixed fee is not agreed upon, then a fee based on the following percentages of the various portions of the Cost of the Work:
 - a. For costs incurred under Paragraphs 13.01.B.1 and 13.01.B.2, the Contractor's fee will be 15 percent;
 - b. For costs incurred under Paragraph 13.01.B.3, the Contractor's fee will be 5 percent;
 - c. Where one or more tiers of subcontracts are on the basis of Cost of the Work plus a fee and no fixed fee is agreed upon, the intent of Paragraphs 11.07.C.2.a and 11.07.C.2.b is that the Contractor's fee will be based on: (1) a fee of 15 percent of the costs incurred under Paragraphs 13.01.B.1 and 13.01.B.2 by the Subcontractor that actually performs the Work, at whatever tier, and (2) with respect to Contractor itself and to any Subcontractors of a tier higher than that of the Subcontractor that actually performs the Work, a fee of 5 percent of the amount (fee plus underlying costs incurred) attributable to the next lower tier Subcontractor; provided, however, that for any such subcontracted Work the maximum total fee to be paid by Owner will be no greater than 27 percent of the costs incurred by the Subcontractor that actually performs the Work;
 - d. No fee will be payable on the basis of costs itemized under Paragraphs 13.01.B.4, 13.01.B.5, and 13.01.C;
 - e. The amount of credit to be allowed by Contractor to Owner for any change which results in a net decrease in Cost of the Work will be the amount of the actual net decrease in Cost of the Work and a deduction of an additional amount equal to 5 percent of such actual net decrease in Cost of the Work; and
 - f. When both additions and credits are involved in any one change or Change Proposal, the adjustment in Contractor's fee will be computed by determining the sum of the costs in each of the cost categories in Paragraph 13.01.B (specifically, payroll costs, Paragraph 13.01.B.1; incorporated materials and equipment costs, Paragraph 13.01.B.2; Subcontract costs, Paragraph 13.01.B.3; special consultants costs, Paragraph 13.01.B.4; and other costs, Paragraph 13.01.B.5) and applying to each such cost category sum the appropriate fee from Paragraphs 11.07.C.2.a through 11.07.C.2.e, inclusive.

11.08 *Change of Contract Times*

- A. The Contract Times may only be changed by a Change Order. Any Change Proposal for an adjustment in the Contract Times must comply with the provisions of Paragraph 11.09. Any Claim for an adjustment in the Contract Times must comply with the provisions of Article 12.
- B. Delay, disruption, and interference in the Work, and any related changes in Contract Times, are addressed in and governed by Paragraph 4.05.

11.09 *Change Proposals*

A. *Purpose and Content:* Contractor shall submit a Change Proposal to Engineer to request an adjustment in the Contract Times or Contract Price; contest an initial decision by Engineer concerning the requirements of the Contract Documents or relating to the acceptability of the Work under the Contract Documents; challenge a set-off against payment due; or seek other relief under the Contract. The Change Proposal will specify any proposed change in Contract Times or Contract Price, or other proposed relief, and explain the reason for the proposed change, with citations to any governing or applicable provisions of the Contract Documents. Each Change Proposal will address only one issue, or a set of closely related issues.

B. *Change Proposal Procedures*

1. *Submittal:* Contractor shall submit each Change Proposal to Engineer within 30 days after the start of the event giving rise thereto, or after such initial decision.
2. *Supporting Data:* The Contractor shall submit supporting data, including the proposed change in Contract Price or Contract Time (if any), to the Engineer and Owner within 15 days after the submittal of the Change Proposal.
 - a. Change Proposals based on or related to delay, interruption, or interference must comply with the provisions of Paragraphs 4.05.D and 4.05.E.
 - b. Change proposals related to a change of Contract Price must include full and detailed accounts of materials incorporated into the Work and labor and equipment used for the subject Work.

The supporting data must be accompanied by a written statement that the supporting data are accurate and complete, and that any requested time or price adjustment is the entire adjustment to which Contractor believes it is entitled as a result of said event.

3. *Engineer's Initial Review:* Engineer will advise Owner regarding the Change Proposal, and consider any comments or response from Owner regarding the Change Proposal. If in its discretion Engineer concludes that additional supporting data is needed before conducting a full review and making a decision regarding the Change Proposal, then Engineer may request that Contractor submit such additional supporting data by a date specified by Engineer, prior to Engineer beginning its full review of the Change Proposal.
4. *Engineer's Full Review and Action on the Change Proposal:* Upon receipt of Contractor's supporting data (including any additional data requested by Engineer), Engineer will conduct a full review of each Change Proposal and, within 30 days after such receipt of the Contractor's supporting data, either approve the Change Proposal in whole, deny it in whole, or approve it in part and deny it in part. Such actions must be in writing, with a copy provided to Owner and Contractor. If Engineer does not take action on the Change

Proposal within 30 days, then either Owner or Contractor may at any time thereafter submit a letter to the other party indicating that as a result of Engineer's inaction the Change Proposal is deemed denied, thereby commencing the time for appeal of the denial under Article 12.

5. *Binding Decision*: Engineer's decision is final and binding upon Owner and Contractor, unless Owner or Contractor appeals the decision by filing a Claim under Article 12.
- C. *Resolution of Certain Change Proposals*: If the Change Proposal does not involve the design (as set forth in the Drawings, Specifications, or otherwise), the acceptability of the Work, or other engineering or technical matters, then Engineer will notify the parties in writing that the Engineer is unable to resolve the Change Proposal. For purposes of further resolution of such a Change Proposal, such notice will be deemed a denial, and Contractor may choose to seek resolution under the terms of Article 12.
- D. *Post-Completion*: Contractor shall not submit any Change Proposals after Engineer issues a written recommendation of final payment pursuant to Paragraph 15.06.B.

11.10 *Notification to Surety*

- A. If the provisions of any bond require notice to be given to a surety of any change affecting the general scope of the Work or the provisions of the Contract Documents (including, but not limited to, Contract Price or Contract Times), the giving of any such notice will be Contractor's responsibility. The amount of each applicable bond will be adjusted to reflect the effect of any such change.

ARTICLE 12—CLAIMS

12.01 *Claims*

- A. *Claims Process*: The following disputes between Owner and Contractor are subject to the Claims process set forth in this article:
 1. Appeals by Owner or Contractor of Engineer's decisions regarding Change Proposals;
 2. Owner demands for adjustments in the Contract Price or Contract Times, or other relief under the Contract Documents;
 3. Disputes that Engineer has been unable to address because they do not involve the design (as set forth in the Drawings, Specifications, or otherwise), the acceptability of the Work, or other engineering or technical matters; and
 4. Subject to the waiver provisions of Paragraph 15.07, any dispute arising after Engineer has issued a written recommendation of final payment pursuant to Paragraph 15.06.B.
- B. *Submittal of Claim*: The party submitting a Claim shall deliver it directly to the other party to the Contract promptly (but in no event later than 30 days) after the start of the event giving rise thereto; in the case of appeals regarding Change Proposals within 30 days of the decision under appeal. The party submitting the Claim shall also furnish a copy to the Engineer, for its information only. The responsibility to substantiate a Claim rests with the party making the Claim. In the case of a Claim by Contractor seeking an increase in the Contract Times or Contract Price, Contractor shall certify that the Claim is made in good faith, that the supporting data are accurate and complete, and that to the best of Contractor's knowledge

and belief the amount of time or money requested accurately reflects the full amount to which Contractor is entitled.

- C. *Review and Resolution*: The party receiving a Claim shall review it thoroughly, giving full consideration to its merits. The two parties shall seek to resolve the Claim through the exchange of information and direct negotiations. The parties may extend the time for resolving the Claim by mutual agreement. All actions taken on a Claim will be stated in writing and submitted to the other party, with a copy to Engineer.
- D. *Mediation*
 - 1. At any time after initiation of a Claim, Owner and Contractor may mutually agree to mediation of the underlying dispute. The agreement to mediate will stay the Claim submittal and response process.
 - 2. If Owner and Contractor agree to mediation, then after 60 days from such agreement, either Owner or Contractor may unilaterally terminate the mediation process, and the Claim submittal and decision process will resume as of the date of the termination. If the mediation proceeds but is unsuccessful in resolving the dispute, the Claim submittal and decision process will resume as of the date of the conclusion of the mediation, as determined by the mediator.
 - 3. Owner and Contractor shall each pay one-half of the mediator's fees and costs.
- E. *Partial Approval*: If the party receiving a Claim approves the Claim in part and denies it in part, such action will be final and binding unless within 30 days of such action the other party invokes the procedure set forth in Article 17 for final resolution of disputes.
- F. *Denial of Claim*: If efforts to resolve a Claim are not successful, the party receiving the Claim may deny it by giving written notice of denial to the other party. If the receiving party does not take action on the Claim within 90 days, then either Owner or Contractor may at any time thereafter submit a letter to the other party indicating that as a result of the inaction, the Claim is deemed denied, thereby commencing the time for appeal of the denial. A denial of the Claim will be final and binding unless within 30 days of the denial the other party invokes the procedure set forth in Article 17 for the final resolution of disputes.
- G. *Final and Binding Results*: If the parties reach a mutual agreement regarding a Claim, whether through approval of the Claim, direct negotiations, mediation, or otherwise; or if a Claim is approved in part and denied in part, or denied in full, and such actions become final and binding; then the results of the agreement or action on the Claim will be incorporated in a Change Order or other written document to the extent they affect the Contract, including the Work, the Contract Times, or the Contract Price.

ARTICLE 13—COST OF THE WORK; ALLOWANCES; UNIT PRICE WORK

13.01 *Cost of the Work*

- A. *Purposes for Determination of Cost of the Work*: The term Cost of the Work means the sum of all costs necessary for the proper performance of the Work at issue, as further defined below. The provisions of this Paragraph 13.01 are used for two distinct purposes:
 - 1. To determine Cost of the Work when Cost of the Work is a component of the Contract Price, under cost-plus-fee, time-and-materials, or other cost-based terms; or

2. When needed to determine the value of a Change Order, Change Proposal, Claim, set-off, or other adjustment in Contract Price. When the value of any such adjustment is determined on the basis of Cost of the Work, Contractor is entitled only to those additional or incremental costs required because of the change in the Work or because of the event giving rise to the adjustment.
- B. *Costs Included:* Except as otherwise may be agreed to in writing by Owner, costs included in the Cost of the Work will be in amounts no higher than those commonly incurred in the locality of the Project, will not include any of the costs itemized in Paragraph 13.01.C, and will include only the following items:
1. Payroll costs for employees in the direct employ of Contractor in the performance of the Work under schedules of job classifications agreed upon by Owner and Contractor in advance of the subject Work. Such employees include, without limitation, superintendents, foremen, safety managers, safety representatives, and other personnel employed full time on the Work. Payroll costs for employees not employed full time on the Work will be apportioned on the basis of their time spent on the Work. Payroll costs include, but are not limited to, salaries and wages plus the cost of fringe benefits, which include social security contributions, unemployment, excise, and payroll taxes, workers' compensation, health and retirement benefits, sick leave, and vacation and holiday pay applicable thereto. The expenses of performing Work outside of regular working hours, on Saturday, Sunday, or legal holidays, will be included in the above to the extent authorized by Owner.
 2. Cost of all materials and equipment furnished and incorporated in the Work, including costs of transportation and storage thereof, and Suppliers' field services required in connection therewith. All cash discounts accrue to Contractor unless Owner deposits funds with Contractor with which to make payments, in which case the cash discounts will accrue to Owner. All trade discounts, rebates, and refunds and returns from sale of surplus materials and equipment will accrue to Owner, and Contractor shall make provisions so that they may be obtained.
 3. Payments made by Contractor to Subcontractors for Work performed by Subcontractors. If required by Owner, Contractor shall obtain competitive bids from subcontractors acceptable to Owner and Contractor and shall deliver such bids to Owner, which will then determine, with the advice of Engineer, which bids, if any, will be acceptable. If any subcontract provides that the Subcontractor is to be paid on the basis of Cost of the Work plus a fee, the Subcontractor's Cost of the Work and fee will be determined in the same manner as Contractor's Cost of the Work and fee as provided in this Paragraph 13.01.
 4. Costs of special consultants (including but not limited to engineers, architects, testing laboratories, surveyors, attorneys, and accountants) employed or retained for services specifically related to the Work.
 5. Other costs consisting of the following:
 - a. The proportion of necessary transportation, travel, and subsistence expenses of Contractor's employees incurred in discharge of duties connected with the Work.
 - b. Cost, including transportation and maintenance, of all materials, supplies, equipment, machinery, appliances, office, and temporary facilities at the Site, which are

consumed in the performance of the Work, and cost, less market value, of such items used but not consumed which remain the property of Contractor.

- 1) In establishing included costs for materials such as scaffolding, plating, or sheeting, consideration will be given to the actual or the estimated life of the material for use on other projects; or rental rates may be established on the basis of purchase or salvage value of such items, whichever is less. Contractor will not be eligible for compensation for such items in an amount that exceeds the purchase cost of such item.

c. *Construction Equipment Rental*

- 1) Rentals of all construction equipment and machinery, and the parts thereof, in accordance with rental agreements approved by Owner as to price (including any surcharge or special rates applicable to overtime use of the construction equipment or machinery), and the costs of transportation, loading, unloading, assembly, dismantling, and removal thereof. All such costs will be in accordance with the terms of said rental agreements. The rental of any such equipment, machinery, or parts must cease when the use thereof is no longer necessary for the Work.
- 2) Costs for equipment and machinery owned by Contractor or a Contractor-related entity will be paid at a rate shown for such equipment in the equipment rental rate book specified in the Supplementary Conditions. An hourly rate will be computed by dividing the monthly rates by 176. These computed rates will include all operating costs.
- 3) With respect to Work that is the result of a Change Order, Change Proposal, Claim, set-off, or other adjustment in Contract Price ("changed Work"), included costs will be based on the time the equipment or machinery is in use on the changed Work and the costs of transportation, loading, unloading, assembly, dismantling, and removal when directly attributable to the changed Work. The cost of any such equipment or machinery, or parts thereof, must cease to accrue when the use thereof is no longer necessary for the changed Work.

- d. Sales, consumer, use, and other similar taxes related to the Work, and for which Contractor is liable, as imposed by Laws and Regulations.
- e. Deposits lost for causes other than negligence of Contractor, any Subcontractor, or anyone directly or indirectly employed by any of them or for whose acts any of them may be liable, and royalty payments and fees for permits and licenses.
- f. Losses and damages (and related expenses) caused by damage to the Work, not compensated by insurance or otherwise, sustained by Contractor in connection with the performance of the Work (except losses and damages within the deductible amounts of builder's risk or other property insurance established in accordance with Paragraph 6.04), provided such losses and damages have resulted from causes other than the negligence of Contractor, any Subcontractor, or anyone directly or indirectly employed by any of them or for whose acts any of them may be liable. Such losses include settlements made with the written consent and approval of Owner. No such losses, damages, and expenses will be included in the Cost of the Work for the purpose of determining Contractor's fee.

- g. The cost of utilities, fuel, and sanitary facilities at the Site.
- h. Minor expenses such as communication service at the Site, express and courier services, and similar petty cash items in connection with the Work.
- i. The costs of premiums for all bonds and insurance that Contractor is required by the Contract Documents to purchase and maintain.

C. *Costs Excluded*: The term Cost of the Work does not include any of the following items:

- 1. Payroll costs and other compensation of Contractor's officers, executives, principals, general managers, engineers, architects, estimators, attorneys, auditors, accountants, purchasing and contracting agents, expeditors, timekeepers, clerks, and other personnel employed by Contractor, whether at the Site or in Contractor's principal or branch office for general administration of the Work and not specifically included in the agreed upon schedule of job classifications referred to in Paragraph 13.01.B.1 or specifically covered by Paragraph 13.01.B.4. The payroll costs and other compensation excluded here are to be considered administrative costs covered by the Contractor's fee.
- 2. The cost of purchasing, renting, or furnishing small tools and hand tools.
- 3. Expenses of Contractor's principal and branch offices other than Contractor's office at the Site.
- 4. Any part of Contractor's capital expenses, including interest on Contractor's capital employed for the Work and charges against Contractor for delinquent payments.
- 5. Costs due to the negligence of Contractor, any Subcontractor, or anyone directly or indirectly employed by any of them or for whose acts any of them may be liable, including but not limited to, the correction of defective Work, disposal of materials or equipment wrongly supplied, and making good any damage to property.
- 6. Expenses incurred in preparing and advancing Claims.
- 7. Other overhead or general expense costs of any kind and the costs of any item not specifically and expressly included in Paragraph 13.01.B.

D. *Contractor's Fee*

- 1. When the Work as a whole is performed on the basis of cost-plus-a-fee, then:
 - a. Contractor's fee for the Work set forth in the Contract Documents as of the Effective Date of the Contract will be determined as set forth in the Agreement.
 - b. for any Work covered by a Change Order, Change Proposal, Claim, set-off, or other adjustment in Contract Price on the basis of Cost of the Work, Contractor's fee will be determined as follows:
 - 1) When the fee for the Work as a whole is a percentage of the Cost of the Work, the fee will automatically adjust as the Cost of the Work changes.
 - 2) When the fee for the Work as a whole is a fixed fee, the fee for any additions or deletions will be determined in accordance with Paragraph 11.07.C.2.
- 2. When the Work as a whole is performed on the basis of a stipulated sum, or any other basis other than cost-plus-a-fee, then Contractor's fee for any Work covered by a Change

Order, Change Proposal, Claim, set-off, or other adjustment in Contract Price on the basis of Cost of the Work will be determined in accordance with Paragraph 11.07.C.2.

- E. *Documentation and Audit:* Whenever the Cost of the Work for any purpose is to be determined pursuant to this Article 13, Contractor and pertinent Subcontractors will establish and maintain records of the costs in accordance with generally accepted accounting practices. Subject to prior written notice, Owner will be afforded reasonable access, during normal business hours, to all Contractor's accounts, records, books, correspondence, instructions, drawings, receipts, vouchers, memoranda, and similar data relating to the Cost of the Work and Contractor's fee. Contractor shall preserve all such documents for a period of three years after the final payment by Owner. Pertinent Subcontractors will afford such access to Owner, and preserve such documents, to the same extent required of Contractor.

13.02 Allowances

- A. It is understood that Contractor has included in the Contract Price all allowances so named in the Contract Documents and shall cause the Work so covered to be performed for such sums and by such persons or entities as may be acceptable to Owner and Engineer.
- B. *Cash Allowances:* Contractor agrees that:
1. the cash allowances include the cost to Contractor (less any applicable trade discounts) of materials and equipment required by the allowances to be delivered at the Site, and all applicable taxes; and
 2. Contractor's costs for unloading and handling on the Site, labor, installation, overhead, profit, and other expenses contemplated for the cash allowances have been included in the Contract Price and not in the allowances, and no demand for additional payment for any of the foregoing will be valid.
- C. *Owner's Contingency Allowance:* Contractor agrees that an Owner's contingency allowance, if any, is for the sole use of Owner to cover unanticipated costs.
- D. Prior to final payment, an appropriate Change Order will be issued as recommended by Engineer to reflect actual amounts due Contractor for Work covered by allowances, and the Contract Price will be correspondingly adjusted.

13.03 Unit Price Work

- A. Where the Contract Documents provide that all or part of the Work is to be Unit Price Work, initially the Contract Price will be deemed to include for all Unit Price Work an amount equal to the sum of the unit price for each separately identified item of Unit Price Work times the estimated quantity of each item as indicated in the Agreement.
- B. The estimated quantities of items of Unit Price Work are not guaranteed and are solely for the purpose of comparison of Bids and determining an initial Contract Price. Payments to Contractor for Unit Price Work will be based on actual quantities.
- C. Each unit price will be deemed to include an amount considered by Contractor to be adequate to cover Contractor's overhead and profit for each separately identified item.
- D. Engineer will determine the actual quantities and classifications of Unit Price Work performed by Contractor. Engineer will review with Contractor the Engineer's preliminary determinations on such matters before rendering a written decision thereon (by recommendation of an Application for Payment or otherwise). Engineer's written decision

thereon will be final and binding (except as modified by Engineer to reflect changed factual conditions or more accurate data) upon Owner and Contractor, and the final adjustment of Contract Price will be set forth in a Change Order, subject to the provisions of the following paragraph.

E. *Adjustments in Unit Price*

1. Contractor or Owner shall be entitled to an adjustment in the unit price with respect to an item of Unit Price Work if:
 - a. the quantity of the item of Unit Price Work performed by Contractor differs materially and significantly from the estimated quantity of such item indicated in the Agreement; and
 - b. Contractor's unit costs to perform the item of Unit Price Work have changed materially and significantly as a result of the quantity change.
2. The adjustment in unit price will account for and be coordinated with any related changes in quantities of other items of Work, and in Contractor's costs to perform such other Work, such that the resulting overall change in Contract Price is equitable to Owner and Contractor.
3. Adjusted unit prices will apply to all units of that item.

ARTICLE 14—TESTS AND INSPECTIONS; CORRECTION, REMOVAL, OR ACCEPTANCE OF DEFECTIVE WORK

14.01 *Access to Work*

- A. Owner, Engineer, their consultants and other representatives and personnel of Owner, independent testing laboratories, and authorities having jurisdiction have access to the Site and the Work at reasonable times for their observation, inspection, and testing. Contractor shall provide them proper and safe conditions for such access and advise them of Contractor's safety procedures and programs so that they may comply with such procedures and programs as applicable.

14.02 *Tests, Inspections, and Approvals*

- A. Contractor shall give Engineer timely notice of readiness of the Work (or specific parts thereof) for all required inspections and tests, and shall cooperate with inspection and testing personnel to facilitate required inspections and tests.
- B. Owner shall retain and pay for the services of an independent inspector, testing laboratory, or other qualified individual or entity to perform all inspections and tests expressly required by the Contract Documents to be furnished and paid for by Owner, except that costs incurred in connection with tests or inspections of covered Work will be governed by the provisions of Paragraph 14.05.
- C. If Laws or Regulations of any public body having jurisdiction require any Work (or part thereof) specifically to be inspected, tested, or approved by an employee or other representative of such public body, Contractor shall assume full responsibility for arranging and obtaining such inspections, tests, or approvals, pay all costs in connection therewith, and furnish Engineer the required certificates of inspection or approval.

- D. Contractor shall be responsible for arranging, obtaining, and paying for all inspections and tests required:
1. by the Contract Documents, unless the Contract Documents expressly allocate responsibility for a specific inspection or test to Owner;
 2. to attain Owner's and Engineer's acceptance of materials or equipment to be incorporated in the Work;
 3. by manufacturers of equipment furnished under the Contract Documents;
 4. for testing, adjusting, and balancing of mechanical, electrical, and other equipment to be incorporated into the Work; and
 5. for acceptance of materials, mix designs, or equipment submitted for approval prior to Contractor's purchase thereof for incorporation in the Work.

Such inspections and tests will be performed by independent inspectors, testing laboratories, or other qualified individuals or entities acceptable to Owner and Engineer.

- E. If the Contract Documents require the Work (or part thereof) to be approved by Owner, Engineer, or another designated individual or entity, then Contractor shall assume full responsibility for arranging and obtaining such approvals.
- F. If any Work (or the work of others) that is to be inspected, tested, or approved is covered by Contractor without written concurrence of Engineer, Contractor shall, if requested by Engineer, uncover such Work for observation. Such uncovering will be at Contractor's expense unless Contractor had given Engineer timely notice of Contractor's intention to cover the same and Engineer had not acted with reasonable promptness in response to such notice.

14.03 *Defective Work*

- A. *Contractor's Obligation:* It is Contractor's obligation to assure that the Work is not defective.
- B. *Engineer's Authority:* Engineer has the authority to determine whether Work is defective, and to reject defective Work.
- C. *Notice of Defects:* Prompt written notice of all defective Work of which Owner or Engineer has actual knowledge will be given to Contractor.
- D. *Correction, or Removal and Replacement:* Promptly after receipt of written notice of defective Work, Contractor shall correct all such defective Work, whether or not fabricated, installed, or completed, or, if Engineer has rejected the defective Work, remove it from the Project and replace it with Work that is not defective.
- E. *Preservation of Warranties:* When correcting defective Work, Contractor shall take no action that would void or otherwise impair Owner's special warranty and guarantee, if any, on said Work.
- F. *Costs and Damages:* In addition to its correction, removal, and replacement obligations with respect to defective Work, Contractor shall pay all claims, costs, losses, and damages arising out of or relating to defective Work, including but not limited to the cost of the inspection, testing, correction, removal, replacement, or reconstruction of such defective Work, fines levied against Owner by governmental authorities because the Work is defective, and the costs of repair or replacement of work of others resulting from defective Work. Prior to final payment, if Owner and Contractor are unable to agree as to the measure of such claims, costs,

losses, and damages resulting from defective Work, then Owner may impose a reasonable set-off against payments due under Article 15.

14.04 *Acceptance of Defective Work*

- A. If, instead of requiring correction or removal and replacement of defective Work, Owner prefers to accept it, Owner may do so (subject, if such acceptance occurs prior to final payment, to Engineer's confirmation that such acceptance is in general accord with the design intent and applicable engineering principles, and will not endanger public safety). Contractor shall pay all claims, costs, losses, and damages attributable to Owner's evaluation of and determination to accept such defective Work (such costs to be approved by Engineer as to reasonableness), and for the diminished value of the Work to the extent not otherwise paid by Contractor. If any such acceptance occurs prior to final payment, the necessary revisions in the Contract Documents with respect to the Work will be incorporated in a Change Order. If the parties are unable to agree as to the decrease in the Contract Price, reflecting the diminished value of Work so accepted, then Owner may impose a reasonable set-off against payments due under Article 15. If the acceptance of defective Work occurs after final payment, Contractor shall pay an appropriate amount to Owner.

14.05 *Uncovering Work*

- A. Engineer has the authority to require additional inspection or testing of the Work, whether or not the Work is fabricated, installed, or completed.
- B. If any Work is covered contrary to the written request of Engineer, then Contractor shall, if requested by Engineer, uncover such Work for Engineer's observation, and then replace the covering, all at Contractor's expense.
- C. If Engineer considers it necessary or advisable that covered Work be observed by Engineer or inspected or tested by others, then Contractor, at Engineer's request, shall uncover, expose, or otherwise make available for observation, inspection, or testing as Engineer may require, that portion of the Work in question, and provide all necessary labor, material, and equipment.
 - 1. If it is found that the uncovered Work is defective, Contractor shall be responsible for all claims, costs, losses, and damages arising out of or relating to such uncovering, exposure, observation, inspection, and testing, and of satisfactory replacement or reconstruction (including but not limited to all costs of repair or replacement of work of others); and pending Contractor's full discharge of this responsibility the Owner shall be entitled to impose a reasonable set-off against payments due under Article 15.
 - 2. If the uncovered Work is not found to be defective, Contractor shall be allowed an increase in the Contract Price or an extension of the Contract Times, directly attributable to such uncovering, exposure, observation, inspection, testing, replacement, and reconstruction. If the parties are unable to agree as to the amount or extent thereof, then Contractor may submit a Change Proposal within 30 days of the determination that the Work is not defective.

14.06 *Owner May Stop the Work*

- A. If the Work is defective, or Contractor fails to supply sufficient skilled workers or suitable materials or equipment, or fails to perform the Work in such a way that the completed Work will conform to the Contract Documents, then Owner may order Contractor to stop the Work,

or any portion thereof, until the cause for such order has been eliminated; however, this right of Owner to stop the Work will not give rise to any duty on the part of Owner to exercise this right for the benefit of Contractor, any Subcontractor, any Supplier, any other individual or entity, or any surety for, or employee or agent of any of them.

14.07 Owner May Correct Defective Work

- A. If Contractor fails within a reasonable time after written notice from Engineer to correct defective Work, or to remove and replace defective Work as required by Engineer, then Owner may, after 7 days' written notice to Contractor, correct or remedy any such deficiency.
- B. In exercising the rights and remedies under this Paragraph 14.07, Owner shall proceed expeditiously. In connection with such corrective or remedial action, Owner may exclude Contractor from all or part of the Site, take possession of all or part of the Work and suspend Contractor's services related thereto, and incorporate in the Work all materials and equipment stored at the Site or for which Owner has paid Contractor but which are stored elsewhere. Contractor shall allow Owner, Owner's representatives, agents and employees, Owner's other contractors, and Engineer and Engineer's consultants access to the Site to enable Owner to exercise the rights and remedies under this paragraph.
- C. All claims, costs, losses, and damages incurred or sustained by Owner in exercising the rights and remedies under this Paragraph 14.07 will be charged against Contractor as set-offs against payments due under Article 15. Such claims, costs, losses and damages will include but not be limited to all costs of repair, or replacement of work of others destroyed or damaged by correction, removal, or replacement of Contractor's defective Work.
- D. Contractor shall not be allowed an extension of the Contract Times because of any delay in the performance of the Work attributable to the exercise by Owner of Owner's rights and remedies under this Paragraph 14.07.

ARTICLE 15—PAYMENTS TO CONTRACTOR; SET-OFFS; COMPLETION; CORRECTION PERIOD

15.01 Progress Payments

- A. *Basis for Progress Payments:* The Schedule of Values established as provided in Article 2 will serve as the basis for progress payments and will be incorporated into a form of Application for Payment acceptable to Engineer. Progress payments for Unit Price Work will be based on the number of units completed during the pay period, as determined under the provisions of Paragraph 13.03. Progress payments for cost-based Work will be based on Cost of the Work completed by Contractor during the pay period.
- B. *Applications for Payments*
 - 1. At least 20 days before the date established in the Agreement for each progress payment (but not more often than once a month), Contractor shall submit to Engineer for review an Application for Payment filled out and signed by Contractor covering the Work completed as of the date of the Application and accompanied by such supporting documentation as is required by the Contract Documents.
 - 2. If payment is requested on the basis of materials and equipment not incorporated in the Work but delivered and suitably stored at the Site or at another location agreed to in writing, the Application for Payment must also be accompanied by: (a) a bill of sale, invoice, copies of subcontract or purchase order payments, or other documentation

establishing full payment by Contractor for the materials and equipment; (b) at Owner's request, documentation warranting that Owner has received the materials and equipment free and clear of all Liens; and (c) evidence that the materials and equipment are covered by appropriate property insurance, a warehouse bond, or other arrangements to protect Owner's interest therein, all of which must be satisfactory to Owner.

3. Beginning with the second Application for Payment, each Application must include an affidavit of Contractor stating that all previous progress payments received by Contractor have been applied to discharge Contractor's legitimate obligations associated with prior Applications for Payment.
4. The amount of retainage with respect to progress payments will be as stipulated in the Agreement.

C. *Review of Applications*

1. Engineer will, within 10 days after receipt of each Application for Payment, including each resubmittal, either indicate in writing a recommendation of payment and present the Application to Owner, or return the Application to Contractor indicating in writing Engineer's reasons for refusing to recommend payment. In the latter case, Contractor may make the necessary corrections and resubmit the Application.
2. Engineer's recommendation of any payment requested in an Application for Payment will constitute a representation by Engineer to Owner, based on Engineer's observations of the executed Work as an experienced and qualified design professional, and on Engineer's review of the Application for Payment and the accompanying data and schedules, that to the best of Engineer's knowledge, information and belief:
 - a. the Work has progressed to the point indicated;
 - b. the quality of the Work is generally in accordance with the Contract Documents (subject to an evaluation of the Work as a functioning whole prior to or upon Substantial Completion, the results of any subsequent tests called for in the Contract Documents, a final determination of quantities and classifications for Unit Price Work under Paragraph 13.03, and any other qualifications stated in the recommendation); and
 - c. the conditions precedent to Contractor's being entitled to such payment appear to have been fulfilled in so far as it is Engineer's responsibility to observe the Work.
3. By recommending any such payment Engineer will not thereby be deemed to have represented that:
 - a. inspections made to check the quality or the quantity of the Work as it has been performed have been exhaustive, extended to every aspect of the Work in progress, or involved detailed inspections of the Work beyond the responsibilities specifically assigned to Engineer in the Contract; or
 - b. there may not be other matters or issues between the parties that might entitle Contractor to be paid additionally by Owner or entitle Owner to withhold payment to Contractor.

4. Neither Engineer's review of Contractor's Work for the purposes of recommending payments nor Engineer's recommendation of any payment, including final payment, will impose responsibility on Engineer:
 - a. to supervise, direct, or control the Work;
 - b. for the means, methods, techniques, sequences, or procedures of construction, or the safety precautions and programs incident thereto;
 - c. for Contractor's failure to comply with Laws and Regulations applicable to Contractor's performance of the Work;
 - d. to make any examination to ascertain how or for what purposes Contractor has used the money paid by Owner; or
 - e. to determine that title to any of the Work, materials, or equipment has passed to Owner free and clear of any Liens.
5. Engineer may refuse to recommend the whole or any part of any payment if, in Engineer's opinion, it would be incorrect to make the representations to Owner stated in Paragraph 15.01.C.2.
6. Engineer will recommend reductions in payment (set-offs) necessary in Engineer's opinion to protect Owner from loss because:
 - a. the Work is defective, requiring correction or replacement;
 - b. the Contract Price has been reduced by Change Orders;
 - c. Owner has been required to correct defective Work in accordance with Paragraph 14.07, or has accepted defective Work pursuant to Paragraph 14.04;
 - d. Owner has been required to remove or remediate a Hazardous Environmental Condition for which Contractor is responsible; or
 - e. Engineer has actual knowledge of the occurrence of any of the events that would constitute a default by Contractor and therefore justify termination for cause under the Contract Documents.

D. *Payment Becomes Due*

1. Ten days after presentation of the Application for Payment to Owner with Engineer's recommendation, the amount recommended (subject to any Owner set-offs) will become due, and when due will be paid by Owner to Contractor.

E. *Reductions in Payment by Owner*

1. In addition to any reductions in payment (set-offs) recommended by Engineer, Owner is entitled to impose a set-off against payment based on any of the following:
 - a. Claims have been made against Owner based on Contractor's conduct in the performance or furnishing of the Work, or Owner has incurred costs, losses, or damages resulting from Contractor's conduct in the performance or furnishing of the Work, including but not limited to claims, costs, losses, or damages from workplace injuries, adjacent property damage, non-compliance with Laws and Regulations, and patent infringement;

- b. Contractor has failed to take reasonable and customary measures to avoid damage, delay, disruption, and interference with other work at or adjacent to the Site;
 - c. Contractor has failed to provide and maintain required bonds or insurance;
 - d. Owner has been required to remove or remediate a Hazardous Environmental Condition for which Contractor is responsible;
 - e. Owner has incurred extra charges or engineering costs related to submittal reviews, evaluations of proposed substitutes, tests and inspections, or return visits to manufacturing or assembly facilities;
 - f. The Work is defective, requiring correction or replacement;
 - g. Owner has been required to correct defective Work in accordance with Paragraph 14.07, or has accepted defective Work pursuant to Paragraph 14.04;
 - h. The Contract Price has been reduced by Change Orders;
 - i. An event has occurred that would constitute a default by Contractor and therefore justify a termination for cause;
 - j. Liquidated or other damages have accrued as a result of Contractor's failure to achieve Milestones, Substantial Completion, or final completion of the Work;
 - k. Liens have been filed in connection with the Work, except where Contractor has delivered a specific bond satisfactory to Owner to secure the satisfaction and discharge of such Liens; or
 - l. Other items entitle Owner to a set-off against the amount recommended.
2. If Owner imposes any set-off against payment, whether based on its own knowledge or on the written recommendations of Engineer, Owner will give Contractor immediate written notice (with a copy to Engineer) stating the reasons for such action and the specific amount of the reduction, and promptly pay Contractor any amount remaining after deduction of the amount so withheld. Owner shall promptly pay Contractor the amount so withheld, or any adjustment thereto agreed to by Owner and Contractor, if Contractor remedies the reasons for such action. The reduction imposed will be binding on Contractor unless it duly submits a Change Proposal contesting the reduction.
 3. Upon a subsequent determination that Owner's refusal of payment was not justified, the amount wrongfully withheld will be treated as an amount due as determined by Paragraph 15.01.D.1 and subject to interest as provided in the Agreement.

15.02 *Contractor's Warranty of Title*

- A. Contractor warrants and guarantees that title to all Work, materials, and equipment furnished under the Contract will pass to Owner free and clear of (1) all Liens and other title defects, and (2) all patent, licensing, copyright, or royalty obligations, no later than 7 days after the time of payment by Owner.

15.03 *Substantial Completion*

- A. When Contractor considers the entire Work ready for its intended use Contractor shall notify Owner and Engineer in writing that the entire Work is substantially complete and request that Engineer issue a certificate of Substantial Completion. Contractor shall at the same time

submit to Owner and Engineer an initial draft of punch list items to be completed or corrected before final payment.

- B. Promptly after Contractor's notification, Owner, Contractor, and Engineer shall make an inspection of the Work to determine the status of completion. If Engineer does not consider the Work substantially complete, Engineer will notify Contractor in writing giving the reasons therefor.
- C. If Engineer considers the Work substantially complete, Engineer will deliver to Owner a preliminary certificate of Substantial Completion which will fix the date of Substantial Completion. Engineer shall attach to the certificate a punch list of items to be completed or corrected before final payment. Owner shall have 7 days after receipt of the preliminary certificate during which to make written objection to Engineer as to any provisions of the certificate or attached punch list. If, after considering the objections to the provisions of the preliminary certificate, Engineer concludes that the Work is not substantially complete, Engineer will, within 14 days after submission of the preliminary certificate to Owner, notify Contractor in writing that the Work is not substantially complete, stating the reasons therefor. If Owner does not object to the provisions of the certificate, or if despite consideration of Owner's objections Engineer concludes that the Work is substantially complete, then Engineer will, within said 14 days, execute and deliver to Owner and Contractor a final certificate of Substantial Completion (with a revised punch list of items to be completed or corrected) reflecting such changes from the preliminary certificate as Engineer believes justified after consideration of any objections from Owner.
- D. At the time of receipt of the preliminary certificate of Substantial Completion, Owner and Contractor will confer regarding Owner's use or occupancy of the Work following Substantial Completion, review the builder's risk insurance policy with respect to the end of the builder's risk coverage, and confirm the transition to coverage of the Work under a permanent property insurance policy held by Owner. Unless Owner and Contractor agree otherwise in writing, Owner shall bear responsibility for security, operation, protection of the Work, property insurance, maintenance, heat, and utilities upon Owner's use or occupancy of the Work.
- E. After Substantial Completion the Contractor shall promptly begin work on the punch list of items to be completed or corrected prior to final payment. In appropriate cases Contractor may submit monthly Applications for Payment for completed punch list items, following the progress payment procedures set forth above.
- F. Owner shall have the right to exclude Contractor from the Site after the date of Substantial Completion subject to allowing Contractor reasonable access to remove its property and complete or correct items on the punch list.

15.04 *Partial Use or Occupancy*

- A. Prior to Substantial Completion of all the Work, Owner may use or occupy any substantially completed part of the Work which has specifically been identified in the Contract Documents, or which Owner, Engineer, and Contractor agree constitutes a separately functioning and usable part of the Work that can be used by Owner for its intended purpose without

significant interference with Contractor's performance of the remainder of the Work, subject to the following conditions:

1. At any time, Owner may request in writing that Contractor permit Owner to use or occupy any such part of the Work that Owner believes to be substantially complete. If and when Contractor agrees that such part of the Work is substantially complete, Contractor, Owner, and Engineer will follow the procedures of Paragraph 15.03.A through 15.03.E for that part of the Work.
2. At any time, Contractor may notify Owner and Engineer in writing that Contractor considers any such part of the Work substantially complete and request Engineer to issue a certificate of Substantial Completion for that part of the Work.
3. Within a reasonable time after either such request, Owner, Contractor, and Engineer shall make an inspection of that part of the Work to determine its status of completion. If Engineer does not consider that part of the Work to be substantially complete, Engineer will notify Owner and Contractor in writing giving the reasons therefor. If Engineer considers that part of the Work to be substantially complete, the provisions of Paragraph 15.03 will apply with respect to certification of Substantial Completion of that part of the Work and the division of responsibility in respect thereof and access thereto.
4. No use or occupancy or separate operation of part of the Work may occur prior to compliance with the requirements of Paragraph 6.04 regarding builder's risk or other property insurance.

15.05 *Final Inspection*

- A. Upon written notice from Contractor that the entire Work or an agreed portion thereof is complete, Engineer will promptly make a final inspection with Owner and Contractor and will notify Contractor in writing of all particulars in which this inspection reveals that the Work, or agreed portion thereof, is incomplete or defective. Contractor shall immediately take such measures as are necessary to complete such Work or remedy such deficiencies.

15.06 *Final Payment*

A. *Application for Payment*

1. After Contractor has, in the opinion of Engineer, satisfactorily completed all corrections identified during the final inspection and has delivered, in accordance with the Contract Documents, all maintenance and operating instructions, schedules, guarantees, bonds, certificates or other evidence of insurance, certificates of inspection, annotated record documents (as provided in Paragraph 7.12), and other documents, Contractor may make application for final payment.
2. The final Application for Payment must be accompanied (except as previously delivered) by:
 - a. all documentation called for in the Contract Documents;
 - b. consent of the surety, if any, to final payment;
 - c. satisfactory evidence that all title issues have been resolved such that title to all Work, materials, and equipment has passed to Owner free and clear of any Liens or other title defects, or will so pass upon final payment.

- d. a list of all duly pending Change Proposals and Claims; and
 - e. complete and legally effective releases or waivers (satisfactory to Owner) of all Lien rights arising out of the Work, and of Liens filed in connection with the Work.
3. In lieu of the releases or waivers of Liens specified in Paragraph 15.06.A.2 and as approved by Owner, Contractor may furnish receipts or releases in full and an affidavit of Contractor that: (a) the releases and receipts include all labor, services, material, and equipment for which a Lien could be filed; and (b) all payrolls, material and equipment bills, and other indebtedness connected with the Work for which Owner might in any way be responsible, or which might in any way result in liens or other burdens on Owner's property, have been paid or otherwise satisfied. If any Subcontractor or Supplier fails to furnish such a release or receipt in full, Contractor may furnish a bond or other collateral satisfactory to Owner to indemnify Owner against any Lien, or Owner at its option may issue joint checks payable to Contractor and specified Subcontractors and Suppliers.
- B. *Engineer's Review of Final Application and Recommendation of Payment:* If, on the basis of Engineer's observation of the Work during construction and final inspection, and Engineer's review of the final Application for Payment and accompanying documentation as required by the Contract Documents, Engineer is satisfied that the Work has been completed and Contractor's other obligations under the Contract have been fulfilled, Engineer will, within 10 days after receipt of the final Application for Payment, indicate in writing Engineer's recommendation of final payment and present the final Application for Payment to Owner for payment. Such recommendation will account for any set-offs against payment that are necessary in Engineer's opinion to protect Owner from loss for the reasons stated above with respect to progress payments. Otherwise, Engineer will return the Application for Payment to Contractor, indicating in writing the reasons for refusing to recommend final payment, in which case Contractor shall make the necessary corrections and resubmit the Application for Payment.
- C. *Notice of Acceptability:* In support of its recommendation of payment of the final Application for Payment, Engineer will also give written notice to Owner and Contractor that the Work is acceptable, subject to stated limitations in the notice and to the provisions of Paragraph 15.07.
- D. *Completion of Work:* The Work is complete (subject to surviving obligations) when it is ready for final payment as established by the Engineer's written recommendation of final payment and issuance of notice of the acceptability of the Work.
- E. *Final Payment Becomes Due:* Upon receipt from Engineer of the final Application for Payment and accompanying documentation, Owner shall set off against the amount recommended by Engineer for final payment any further sum to which Owner is entitled, including but not limited to set-offs for liquidated damages and set-offs allowed under the provisions of this Contract with respect to progress payments. Owner shall pay the resulting balance due to Contractor within 30 days of Owner's receipt of the final Application for Payment from Engineer.

15.07 *Waiver of Claims*

- A. By making final payment, Owner waives its claim or right to liquidated damages or other damages for late completion by Contractor, except as set forth in an outstanding Claim,

appeal under the provisions of Article 17, set-off, or express reservation of rights by Owner. Owner reserves all other claims or rights after final payment.

- B. The acceptance of final payment by Contractor will constitute a waiver by Contractor of all claims and rights against Owner other than those pending matters that have been duly submitted as a Claim, or appealed under the provisions of Article 17.

15.08 *Correction Period*

- A. If within one year after the date of Substantial Completion (or such longer period of time as may be prescribed by the Supplementary Conditions or the terms of any applicable special guarantee required by the Contract Documents), Owner gives Contractor written notice that any Work has been found to be defective, or that Contractor's repair of any damages to the Site or adjacent areas has been found to be defective, then after receipt of such notice of defect Contractor shall promptly, without cost to Owner and in accordance with Owner's written instructions:
 - 1. correct the defective repairs to the Site or such adjacent areas;
 - 2. correct such defective Work;
 - 3. remove the defective Work from the Project and replace it with Work that is not defective, if the defective Work has been rejected by Owner, and
 - 4. satisfactorily correct or repair or remove and replace any damage to other Work, to the work of others, or to other land or areas resulting from the corrective measures.
- B. Owner shall give any such notice of defect within 60 days of the discovery that such Work or repairs is defective. If such notice is given within such 60 days but after the end of the correction period, the notice will be deemed a notice of defective Work under Paragraph 7.17.B.
- C. If, after receipt of a notice of defect within 60 days and within the correction period, Contractor does not promptly comply with the terms of Owner's written instructions, or in an emergency where delay would cause serious risk of loss or damage, Owner may have the defective Work corrected or repaired or may have the rejected Work removed and replaced. Contractor shall pay all costs, losses, and damages (including but not limited to all fees and charges of engineers, architects, attorneys, and other professionals and all court or arbitration or other dispute resolution costs) arising out of or relating to such correction or repair or such removal and replacement (including but not limited to all costs of repair or replacement of work of others). Contractor's failure to pay such costs, losses, and damages within 10 days of invoice from Owner will be deemed the start of an event giving rise to a Claim under Paragraph 12.01.B, such that any related Claim must be brought within 30 days of the failure to pay.
- D. In special circumstances where a particular item of equipment is placed in continuous service before Substantial Completion of all the Work, the correction period for that item may start to run from an earlier date if so provided in the Specifications.
- E. Where defective Work (and damage to other Work resulting therefrom) has been corrected or removed and replaced under this paragraph, the correction period hereunder with respect to such Work will be extended for an additional period of one year after such correction or removal and replacement has been satisfactorily completed.

- F. Contractor's obligations under this paragraph are in addition to all other obligations and warranties. The provisions of this paragraph are not to be construed as a substitute for, or a waiver of, the provisions of any applicable statute of limitation or repose.

ARTICLE 16—SUSPENSION OF WORK AND TERMINATION

16.01 *Owner May Suspend Work*

- A. At any time and without cause, Owner may suspend the Work or any portion thereof for a period of not more than 90 consecutive days by written notice to Contractor and Engineer. Such notice will fix the date on which Work will be resumed. Contractor shall resume the Work on the date so fixed. Contractor shall be entitled to an adjustment in the Contract Price or an extension of the Contract Times directly attributable to any such suspension. Any Change Proposal seeking such adjustments must be submitted no later than 30 days after the date fixed for resumption of Work.

16.02 *Owner May Terminate for Cause*

- A. The occurrence of any one or more of the following events will constitute a default by Contractor and justify termination for cause:
 - 1. Contractor's persistent failure to perform the Work in accordance with the Contract Documents (including, but not limited to, failure to supply sufficient skilled workers or suitable materials or equipment, or failure to adhere to the Progress Schedule);
 - 2. Failure of Contractor to perform or otherwise to comply with a material term of the Contract Documents;
 - 3. Contractor's disregard of Laws or Regulations of any public body having jurisdiction; or
 - 4. Contractor's repeated disregard of the authority of Owner or Engineer.
- B. If one or more of the events identified in Paragraph 16.02.A occurs, then after giving Contractor (and any surety) 10 days' written notice that Owner is considering a declaration that Contractor is in default and termination of the Contract, Owner may proceed to:
 - 1. declare Contractor to be in default, and give Contractor (and any surety) written notice that the Contract is terminated; and
 - 2. enforce the rights available to Owner under any applicable performance bond.
- C. Subject to the terms and operation of any applicable performance bond, if Owner has terminated the Contract for cause, Owner may exclude Contractor from the Site, take possession of the Work, incorporate in the Work all materials and equipment stored at the Site or for which Owner has paid Contractor but which are stored elsewhere, and complete the Work as Owner may deem expedient.
- D. Owner may not proceed with termination of the Contract under Paragraph 16.02.B if Contractor within 7 days of receipt of notice of intent to terminate begins to correct its failure to perform and proceeds diligently to cure such failure.
- E. If Owner proceeds as provided in Paragraph 16.02.B, Contractor shall not be entitled to receive any further payment until the Work is completed. If the unpaid balance of the Contract Price exceeds the cost to complete the Work, including all related claims, costs, losses, and damages (including but not limited to all fees and charges of engineers, architects,

attorneys, and other professionals) sustained by Owner, such excess will be paid to Contractor. If the cost to complete the Work including such related claims, costs, losses, and damages exceeds such unpaid balance, Contractor shall pay the difference to Owner. Such claims, costs, losses, and damages incurred by Owner will be reviewed by Engineer as to their reasonableness and, when so approved by Engineer, incorporated in a Change Order. When exercising any rights or remedies under this paragraph, Owner shall not be required to obtain the lowest price for the Work performed.

- F. Where Contractor's services have been so terminated by Owner, the termination will not affect any rights or remedies of Owner against Contractor then existing or which may thereafter accrue, or any rights or remedies of Owner against Contractor or any surety under any payment bond or performance bond. Any retention or payment of money due Contractor by Owner will not release Contractor from liability.
- G. If and to the extent that Contractor has provided a performance bond under the provisions of Paragraph 6.01.A, the provisions of that bond will govern over any inconsistent provisions of Paragraphs 16.02.B and 16.02.D.

16.03 *Owner May Terminate for Convenience*

- A. Upon 7 days' written notice to Contractor and Engineer, Owner may, without cause and without prejudice to any other right or remedy of Owner, terminate the Contract. In such case, Contractor shall be paid for (without duplication of any items):
 - 1. completed and acceptable Work executed in accordance with the Contract Documents prior to the effective date of termination, including fair and reasonable sums for overhead and profit on such Work;
 - 2. expenses sustained prior to the effective date of termination in performing services and furnishing labor, materials, or equipment as required by the Contract Documents in connection with uncompleted Work, plus fair and reasonable sums for overhead and profit on such expenses; and
 - 3. other reasonable expenses directly attributable to termination, including costs incurred to prepare a termination for convenience cost proposal.
- B. Contractor shall not be paid for any loss of anticipated profits or revenue, post-termination overhead costs, or other economic loss arising out of or resulting from such termination.

16.04 *Contractor May Stop Work or Terminate*

- A. If, through no act or fault of Contractor, (1) the Work is suspended for more than 90 consecutive days by Owner or under an order of court or other public authority, or (2) Engineer fails to act on any Application for Payment within 30 days after it is submitted, or (3) Owner fails for 30 days to pay Contractor any sum finally determined to be due, then Contractor may, upon 7 days' written notice to Owner and Engineer, and provided Owner or Engineer do not remedy such suspension or failure within that time, terminate the contract and recover from Owner payment on the same terms as provided in Paragraph 16.03.
- B. In lieu of terminating the Contract and without prejudice to any other right or remedy, if Engineer has failed to act on an Application for Payment within 30 days after it is submitted, or Owner has failed for 30 days to pay Contractor any sum finally determined to be due, Contractor may, 7 days after written notice to Owner and Engineer, stop the Work until payment is made of all such amounts due Contractor, including interest thereon. The

provisions of this paragraph are not intended to preclude Contractor from submitting a Change Proposal for an adjustment in Contract Price or Contract Times or otherwise for expenses or damage directly attributable to Contractor's stopping the Work as permitted by this paragraph.

ARTICLE 17—FINAL RESOLUTION OF DISPUTES

17.01 *Methods and Procedures*

- A. *Disputes Subject to Final Resolution:* The following disputed matters are subject to final resolution under the provisions of this article:
1. A timely appeal of an approval in part and denial in part of a Claim, or of a denial in full, pursuant to Article 12; and
 2. Disputes between Owner and Contractor concerning the Work, or obligations under the Contract Documents, that arise after final payment has been made.
- B. *Final Resolution of Disputes:* For any dispute subject to resolution under this article, Owner or Contractor may:
1. elect in writing to invoke the dispute resolution process provided for in the Supplementary Conditions;
 2. agree with the other party to submit the dispute to another dispute resolution process; or
 3. if no dispute resolution process is provided for in the Supplementary Conditions or mutually agreed to, give written notice to the other party of the intent to submit the dispute to a court of competent jurisdiction.

ARTICLE 18—MISCELLANEOUS

18.01 *Giving Notice*

- A. Whenever any provision of the Contract requires the giving of written notice to Owner, Engineer, or Contractor, it will be deemed to have been validly given only if delivered:
1. in person, by a commercial courier service or otherwise, to the recipient's place of business;
 2. by registered or certified mail, postage prepaid, to the recipient's place of business; or
 3. by e-mail to the recipient, with the words "Formal Notice" or similar in the e-mail's subject line.

18.02 *Computation of Times*

- A. When any period of time is referred to in the Contract by days, it will be computed to exclude the first and include the last day of such period. If the last day of any such period falls on a Saturday or Sunday or on a day made a legal holiday by the law of the applicable jurisdiction, such day will be omitted from the computation.

18.03 *Cumulative Remedies*

- A. The duties and obligations imposed by these General Conditions and the rights and remedies available hereunder to the parties hereto are in addition to, and are not to be construed in any way as a limitation of, any rights and remedies available to any or all of them which are otherwise imposed or available by Laws or Regulations, by special warranty or guarantee, or by other provisions of the Contract. The provisions of this paragraph will be as effective as if repeated specifically in the Contract Documents in connection with each particular duty, obligation, right, and remedy to which they apply.

18.04 *Limitation of Damages*

- A. With respect to any and all Change Proposals, Claims, disputes subject to final resolution, and other matters at issue, neither Owner nor Engineer, nor any of their officers, directors, members, partners, employees, agents, consultants, or subcontractors, shall be liable to Contractor for any claims, costs, losses, or damages sustained by Contractor on or in connection with any other project or anticipated project.

18.05 *No Waiver*

- A. A party's non-enforcement of any provision will not constitute a waiver of that provision, nor will it affect the enforceability of that provision or of the remainder of this Contract.

18.06 *Survival of Obligations*

- A. All representations, indemnifications, warranties, and guarantees made in, required by, or given in accordance with the Contract, as well as all continuing obligations indicated in the Contract, will survive final payment, completion, and acceptance of the Work or termination of the Contract or of the services of Contractor.

18.07 *Controlling Law*

- A. This Contract is to be governed by the law of the state in which the Project is located.

18.08 *Assignment of Contract*

- A. Unless expressly agreed to elsewhere in the Contract, no assignment by a party to this Contract of any rights under or interests in the Contract will be binding on the other party without the written consent of the party sought to be bound; and, specifically but without limitation, money that may become due and money that is due may not be assigned without such consent (except to the extent that the effect of this restriction may be limited by law), and unless specifically stated to the contrary in any written consent to an assignment, no assignment will release or discharge the assignor from any duty or responsibility under the Contract.

18.09 *Successors and Assigns*

- A. Owner and Contractor each binds itself, its successors, assigns, and legal representatives to the other party hereto, its successors, assigns, and legal representatives in respect to all covenants, agreements, and obligations contained in the Contract Documents.

18.10 *Headings*

- A. Article and paragraph headings are inserted for convenience only and do not constitute parts of these General Conditions.

SECTION I
WAGE RATE

"General Decision Number: TX20240256 04/05/2024

Superseded General Decision Number: TX20230256

State: Texas

Construction Type: Building

County: Jefferson County in Texas.

BUILDING CONSTRUCTION PROJECTS (does not include single family homes or apartments up to and including 4 stories).

Note: Contracts subject to the Davis-Bacon Act are generally required to pay at least the applicable minimum wage rate required under Executive Order 14026 or Executive Order 13658. Please note that these Executive Orders apply to covered contracts entered into by the federal government that are subject to the Davis-Bacon Act itself, but do not apply to contracts subject only to the Davis-Bacon Related Acts, including those set forth at 29 CFR 5.1(a)(1).

If the contract is entered into on or after January 30, 2022, or the contract is renewed or extended (e.g., an option is exercised) on or after January 30, 2022:	<ul style="list-style-type: none">. Executive Order 14026 generally applies to the contract.. The contractor must pay all covered workers at least \$17.20 per hour (or the applicable wage rate listed on this wage determination, if it is higher) for all hours spent performing on the contract in 2024.
If the contract was awarded on or between January 1, 2015 and January 29, 2022, and the contract is not renewed or extended on or after January 30, 2022:	<ul style="list-style-type: none">. Executive Order 13658 generally applies to the contract.. The contractor must pay all covered workers at least \$12.90 per hour (or the applicable wage rate listed on this wage determination, if it is higher) for all hours spent performing on that contract in 2024.

The applicable Executive Order minimum wage rate will be adjusted annually. If this contract is covered by one of the Executive Orders and a classification considered necessary for performance of work on the contract does not appear on this wage determination, the contractor must still submit a conformance request.

Additional information on contractor requirements and worker protections under the Executive Orders is available at <http://www.dol.gov/whd/govcontracts>.

Modification Number	Publication Date
0	01/05/2024
1	04/05/2024

ASBE0022-009 07/03/2023

	Rates	Fringes
ASBESTOS WORKER/HEAT & FROST INSULATOR (Duct, Pipe and Mechanical System Insulation)....	\$ 28.35	16.02

BOIL0074-003 07/01/2023

	Rates	Fringes
BOILERMAKER.....	\$ 37.00	24.64

* BRTX0005-006 06/01/2023

	Rates	Fringes
BRICKLAYER.....	\$ 27.55	3.25

ELEC0479-005 09/25/2023

	Rates	Fringes
ELECTRICIAN.....	\$ 32.76	13.22

ENGI0450-002 04/01/2014

	Rates	Fringes
POWER EQUIPMENT OPERATOR Cranes.....	\$ 34.85	9.85

IRON0084-011 06/01/2023

	Rates	Fringes
IRONWORKER, ORNAMENTAL.....	\$ 27.51	8.13

IRON0135-002 09/01/2022

	Rates	Fringes
IRONWORKER, STRUCTURAL.....	\$ 34.35	14.44

PLUM0068-001 10/01/2023

	Rates	Fringes
PLUMBER.....	\$ 34.86	11.68

PLUM0211-009 10/01/2023

	Rates	Fringes
PIPEFITTER.....	\$ 38.31	12.61

SHEE0054-007 04/01/2020

	Rates	Fringes
SHEET METAL WORKER (Excludes HVAC Duct Installation).....	\$ 28.69	14.13

* SUTX2014-032 07/21/2014

	Rates	Fringes
CARPENTER.....	\$ 17.98	3.72
CEMENT MASON/CONCRETE FINISHER...	\$ 13.44 **	0.00
FORM WORKER.....	\$ 13.02 **	0.00
IRONWORKER, REINFORCING.....	\$ 12.95 **	0.00
LABORER: Common or General.....	\$ 12.04 **	0.00
LABORER: Mason Tender - Brick...	\$ 12.90 **	0.00
LABORER: Mason Tender - Cement/Concrete.....	\$ 10.50 **	0.00
LABORER: Pipelayer.....	\$ 13.47 **	0.00
LABORER: Roof Tearoff.....	\$ 11.28 **	0.00
LABORER: Landscape and Irrigation.....	\$ 11.04 **	0.36
OPERATOR: Backhoe/Excavator/Trackhoe.....	\$ 18.65	0.00
OPERATOR: Bobcat/Skid Steer/Skid Loader.....	\$ 13.93 **	0.00
OPERATOR: Bulldozer.....	\$ 18.88	0.00
OPERATOR: Drill.....	\$ 16.22 **	0.34
OPERATOR: Forklift.....	\$ 17.69	0.00
OPERATOR: Grader/Blade.....	\$ 13.37 **	0.00
OPERATOR: Loader.....	\$ 13.55 **	0.94
OPERATOR: Mechanic.....	\$ 17.52	3.33
OPERATOR: Paver (Asphalt, Aggregate, and Concrete).....	\$ 16.03 **	0.00
OPERATOR: Roller.....	\$ 16.00 **	0.00
PAINTER (Brush, Roller, and Spray).....	\$ 16.75 **	4.51
ROOFER.....	\$ 15.40 **	0.00
SHEET METAL WORKER (HVAC Duct Installation Only).....	\$ 26.89	10.38
TILE FINISHER.....	\$ 12.00 **	0.00
TILE SETTER.....	\$ 16.17 **	0.00
TRUCK DRIVER: Dump Truck.....	\$ 12.39 **	1.18
TRUCK DRIVER: Flatbed Truck.....	\$ 19.65	8.57

TRUCK DRIVER: Semi-Trailer		
Truck.....	\$ 12.50 **	0.00
TRUCK DRIVER: Water Truck.....	\$ 12.00 **	4.11

WELDERS - Receive rate prescribed for craft performing operation to which welding is incidental.

=====

** Workers in this classification may be entitled to a higher minimum wage under Executive Order 14026 (\$17.20) or 13658 (\$12.90). Please see the Note at the top of the wage determination for more information. Please also note that the minimum wage requirements of Executive Order 14026 are not currently being enforced as to any contract or subcontract to which the states of Texas, Louisiana, or Mississippi, including their agencies, are a party.

Note: Executive Order (EO) 13706, Establishing Paid Sick Leave for Federal Contractors applies to all contracts subject to the Davis-Bacon Act for which the contract is awarded (and any solicitation was issued) on or after January 1, 2017. If this contract is covered by the EO, the contractor must provide employees with 1 hour of paid sick leave for every 30 hours they work, up to 56 hours of paid sick leave each year. Employees must be permitted to use paid sick leave for their own illness, injury or other health-related needs, including preventive care; to assist a family member (or person who is like family to the employee) who is ill, injured, or has other health-related needs, including preventive care; or for reasons resulting from, or to assist a family member (or person who is like family to the employee) who is a victim of, domestic violence, sexual assault, or stalking. Additional information on contractor requirements and worker protections under the EO is available at <https://www.dol.gov/agencies/whd/government-contracts>.

Unlisted classifications needed for work not included within the scope of the classifications listed may be added after award only as provided in the labor standards contract clauses (29CFR 5.5 (a) (1) (iii)).

The body of each wage determination lists the classification and wage rates that have been found to be prevailing for the cited type(s) of construction in the area covered by the wage determination. The classifications are listed in alphabetical order of ""identifiers"" that indicate whether the particular rate is a union rate (current union negotiated rate for local), a survey rate (weighted average rate) or a union average rate (weighted union average rate).

Union Rate Identifiers

A four letter classification abbreviation identifier enclosed in dotted lines beginning with characters other than ""SU"" or ""UAVG"" denotes that the union classification and rate were prevailing for that classification in the survey. Example: PLUM0198-005 07/01/2014. PLUM is an abbreviation identifier of the union which prevailed in the survey for this

classification, which in this example would be Plumbers. 0198 indicates the local union number or district council number where applicable, i.e., Plumbers Local 0198. The next number, 005 in the example, is an internal number used in processing the wage determination. 07/01/2014 is the effective date of the most current negotiated rate, which in this example is July 1, 2014.

Union prevailing wage rates are updated to reflect all rate changes in the collective bargaining agreement (CBA) governing this classification and rate.

Survey Rate Identifiers

Classifications listed under the "SU" identifier indicate that no one rate prevailed for this classification in the survey and the published rate is derived by computing a weighted average rate based on all the rates reported in the survey for that classification. As this weighted average rate includes all rates reported in the survey, it may include both union and non-union rates. Example: SULA2012-007 5/13/2014. SU indicates the rates are survey rates based on a weighted average calculation of rates and are not majority rates. LA indicates the State of Louisiana. 2012 is the year of survey on which these classifications and rates are based. The next number, 007 in the example, is an internal number used in producing the wage determination. 5/13/2014 indicates the survey completion date for the classifications and rates under that identifier.

Survey wage rates are not updated and remain in effect until a new survey is conducted.

Union Average Rate Identifiers

Classification(s) listed under the UAVG identifier indicate that no single majority rate prevailed for those classifications; however, 100% of the data reported for the classifications was union data. EXAMPLE: UAVG-OH-0010 08/29/2014. UAVG indicates that the rate is a weighted union average rate. OH indicates the state. The next number, 0010 in the example, is an internal number used in producing the wage determination. 08/29/2014 indicates the survey completion date for the classifications and rates under that identifier.

A UAVG rate will be updated once a year, usually in January of each year, to reflect a weighted average of the current negotiated/CBA rate of the union locals from which the rate is based.

WAGE DETERMINATION APPEALS PROCESS

1.) Has there been an initial decision in the matter? This can be:

- * an existing published wage determination
- * a survey underlying a wage determination
- * a Wage and Hour Division letter setting forth a position on a wage determination matter
- * a conformance (additional classification and rate) ruling

On survey related matters, initial contact, including requests

for summaries of surveys, should be with the Wage and Hour National Office because National Office has responsibility for the Davis-Bacon survey program. If the response from this initial contact is not satisfactory, then the process described in 2.) and 3.) should be followed.

With regard to any other matter not yet ripe for the formal process described here, initial contact should be with the Branch of Construction Wage Determinations. Write to:

Branch of Construction Wage Determinations
Wage and Hour Division
U.S. Department of Labor
200 Constitution Avenue, N.W.
Washington, DC 20210

2.) If the answer to the question in 1.) is yes, then an interested party (those affected by the action) can request review and reconsideration from the Wage and Hour Administrator (See 29 CFR Part 1.8 and 29 CFR Part 7). Write to:

Wage and Hour Administrator
U.S. Department of Labor
200 Constitution Avenue, N.W.
Washington, DC 20210

The request should be accompanied by a full statement of the interested party's position and by any information (wage payment data, project description, area practice material, etc.) that the requestor considers relevant to the issue.

3.) If the decision of the Administrator is not favorable, an interested party may appeal directly to the Administrative Review Board (formerly the Wage Appeals Board). Write to:

Administrative Review Board
U.S. Department of Labor
200 Constitution Avenue, N.W.
Washington, DC 20210

4.) All decisions by the Administrative Review Board are final.

=====

END OF GENERAL DECISION"

SECTION J
DIVERSITY IN CONTRACTING

Diversity in Contracting Program

Contractor agrees to use its best efforts to implement the Port's Diversity in Contracting Program in connection with this Project. The Port's Policy Directive on Diversity in Contracting has been provided to Contractor as part of these specifications and can also be found on the Port's website at www.portpa.com.

Port of Port Arthur Navigation District of Jefferson County, Texas

POLICY DIRECTIVE ON DIVERSITY IN CONTRACTING

Adopted JUNE 24, 2020

SECTION 1. Purpose.

The Board of Commissioners of the Port of Port Arthur have determined a need to increase the number of local, minority, veteran and women owned businesses utilized on Port contracts. The purpose of this policy directive is to increase the utilization of Port revenues from taxes and operations to assist local, minority, veteran and women owned businesses by providing increased opportunities for participation in contracting for public works, consulting services, supplies, material, equipment, and other services required by the Port.

SECTION 2. Definitions.

For the purposes of this policy directive:

"Affirmative efforts" means documented reasonable attempts in good faith to contract with minority, veteran and women owned businesses.

"Availability" or "available" means a business that is interested in and capable of performing the work within the time frame required and to the quality specified in the solicitation and contract.

"Capability" or "capable" means that a business appears able to perform a commercially useful function in performance of the work.

"Commercially useful function" means the performance of real and actual services in the discharge of any contractual endeavor.

"Contract" means an agreement for public works, consulting services, supplies, material, equipment, or other services.

"Contractor" means a business that has a contract with the Port.

"Local" means within the boundaries of the Port of Port Arthur Navigation District of Jefferson County, Texas.

"Local Plus" means within the nine county region comprised of Jefferson, Orange, Hardin, Jasper, Newton, Liberty, Tyler and Chambers counties, as well as the Bolivar Peninsula area of Galveston County.

"Relevant demographic data" is defined as, but not limited to, Asian-Pacific Americans, Black Americans, Hispanic Americans, Native Americans, Asian, and Women, and other characteristic information related to a business owner's

sexual orientation, sex/gender, race, ethnicity, physical ability, or veteran status as self-reported and/or certified by another government entity, as deemed necessary or relevant to eliminating disparity in Port contracting.

“Utilization” is defined as both the percent of contracting dollars paid to MVW firms as well as the number of MVW firms under contract.

“Minority, veteran, or women owned business” (MVW) means a business that is at least 51 percent owned and controlled by minorities, veterans and/or women (including, but not limited to Asian-Pacific Americans, Black Americans, Hispanic Americans, Native Americans, Asian, Service-Disabled Veterans, and Women, and other characteristic information related to a business owner’s sexual orientation, sex/gender, race, ethnicity, physical ability, or veteran status as self-reported and/or certified by another government entity, as deemed necessary or relevant to eliminating disparity in Port contracting).

SECTION 3. Scope and Applicability.

This policy directive shall apply to all types of procurement contracts with the Port, including construction and consulting contracts, purchased goods, and services.

SECTION 4. Responsibilities.

The Board of Commissioners shall establish goals to increase MVW utilization for the Executive Director and staff in Port contracts and shall:

- A. Expand opportunities for MVW firms across Port functions, wherever practicable;
- B. Pursue the goal to substantially increase the number of MVW firms that contract with the Port and thereby substantially increase the percentage of dollars spent on MVW contracts, effective immediately upon the adoption of this policy directive;
- C. Within 120 days of adoption of this policy directive, develop a Diversity in Contracting Program that identifies affirmative efforts to afford MVW owned businesses the maximum practicable opportunity to participate in Port contracts;
- D. Incorporate the MVW goals into the Port’s Diversity in Contracting Program to the fullest extent reasonable, including incorporation into scorecards, reports, and project plan updates. The Port shall prepare and publish an annual report each year entitled “Port of Port Arthur Diversity in Contracting Annual Report”;
- E. Establish and improve outreach efforts to increase and sustain MVW participation in Port contracting;
and
- F. Take affirmative efforts to assure equality of contracting opportunity through the development and application of inclusion plans or other tools as necessary.

SECTION 5. Policy.

- A. The Port’s Diversity in Contracting Program shall include:
 - (1) Responsibilities, policies, practices, and processes that can improve the Port procurement and contracting processes to provide a more receptive environment for the utilization of MVW firms, and

to ensure that businesses and contractors of all tiers working on Port contracts and subcontracts utilize MVW firms, wherever feasible or as required;

(2) Development of a standard procedure for the Port-wide MVW goal setting, and collection and reporting of relevant demographic data to be stored in a central database;

(3) Identify categories of contracts that will require MVW inclusion plans and other tools that will be applied to other categories of contracts Port-wide;

(4) Clear lines of responsibility and accountability for implementation of the MVW program; and

(5) Make MVW goal-setting and affirmative implementation efforts part of the annual performance evaluation for each Port department head/supervisor and require standardized MVW program training, implementation, and coordination for all department leaders and their MVW representatives.

B. The Port's Diversity in Contracting Annual Report shall include:

(1) The Port's prior year increase in utilization of MVWs to reduce disparity in Port contracting; and

(2) The achievement of goals by department for MVW utilization based on:

(a) Each Port department head/supervisor's review of future procurements to identify available firms on upcoming contracts to create a utilization goal that is justifiable, bold, and challenging; and

(b) Construction goals based on historic utilization plus an established percentage, until such time that a disparity study or other valid internal data can demonstrate a reasonable level of utilization.

C. To improve inclusion and outreach to improve and sustain MVW participation and to reduce disparity in Port contracting, the Port shall:

(1) Support training and assistance to Port staff to increase participation in outreach and to learn about the internal and external resources available to include MVW firms in the Port's procurement and contracting;

(2) Improve and expand technical assistance, including MVW certification, business development, training, and mentoring programs for MVW firms to enhance bidding expertise and promote greater coordination with advocacy organizations, businesses, individuals, and public agencies and other Port departments;

(3) Create opportunities for members of the contracting and vendor community, Port, and other stakeholders to work collaboratively on recommendations for the Port to more effectively use the directives in this policy directive;

(4) Assist contractors desiring to bid on Port contracts to comply with the affirmative efforts provisions for such contract, and offer information as to organizations and agencies available to

assist such contractors in recruiting, mentoring, training, or otherwise preparing potential subcontractors; and

(5) Cooperate and establish formal and/or informal partnerships and mutual cooperation with other public agencies to carry out the purposes of this policy directive, as needed.

D. Affirmative efforts to assure equality of contracting opportunity required:

(1) Develop procurement tools, such as MVW inclusion plans, and require bidders and proposers to comply with the MVW solicitation requirement in order to improve and sustain participation of MVW in Port contracts;

(2) Identify and implement a Port-wide method to regularly monitor and measure the Port MVW program and attainment of goals by contractors;

(3) Establish goals for participation of MVW owned businesses in a particular Port contract on a case-by-case basis;

(4) Work closely with other departments to ensure all policies, practices, and processes are consistent and complementary to make it easier for MVW firms to pursue Port contracts; and

(5) Review certifications and determine whether vendors meet program requirements.

E. Affirmative efforts in subcontracting:

(1) All contractors, including MVW firms, shall actively solicit bids for subcontracts to qualified, available, and capable MVW businesses to perform commercially useful functions;

(2) Contractors shall consider the grant of subcontracts to MVW bidders on the basis of substantially equal proposals in the light most favorable to MVW businesses;

(3) At the request of the relevant Port department, when inclusion plans are required, contractors shall furnish evidence of the contractor's compliance with the Port's requirements for MVW solicitation and will submit evidence of compliance with this section as part of any bid.

(4) Contractors shall provide records necessary to document affirmative efforts to subcontract with MVW businesses on Port contracts;

(5) At any time during a contract in which an inclusion plan is required, Port shall request and contractors shall furnish evidence of the contractor's compliance with these requirements of MVW solicitation and affirmative efforts to subcontract with MVW businesses;

(6) Compliance with all requirements and past performance under this policy directive may be included in the evaluation of future procurements; and

(7) In applying the provisions of this policy directive to contracts funded in whole or in part with federal funds and subject to 49 CFR Part 23, Subpart D, regarding Airport Concessions Disadvantaged Business Enterprises (ACDBE) or 49 CFR 26, Subpart C, regarding Disadvantaged Business Enterprises (DBE), references to Women and Minority Businesses shall also include federally recognized ACDBEs

or DBEs. In the event of a conflict between the provisions of this chapter, or the rules implementing this policy directive, and the requirements of 49 CFR 26, Subpart C, or 49 CFR Part 23, Subpart D, or any other superseding applicable federal statute or regulation, the provisions of the federal statute or regulation shall control.

F. Expanding Opportunity.

(1) The Port shall immediately commence review and recommend measures to expand opportunities for MVW firms in other Port enterprise opportunities, for example real estate leases, to encourage and promote access to Port facilities by MVW firms.

SECTION 6. Local Preference.

A. To be deemed a Local business or Local Plus business in this Program, businesses must first successfully complete Registration and provide other documentation as may be reasonably required by the Port.

B. A Local business means a business with its principal place of business within the Port of Port Arthur Navigation District, Jefferson County, Texas.

C. A Local Plus business means a business with its principal place of business within Jefferson, Orange, Hardin, Jasper, Newton, Liberty, Tyler and Chambers counties, as well as the Bolivar Peninsula area of Galveston County in the State of Texas.

D. Principal place of business means the business must:

(1) Be headquartered within the limits of the applicable jurisdiction as stated in A. or B. above; or

(2) Have an established place or places of business within the limits of the applicable jurisdiction in A. or B. above from which 20% or more of the entity's workforce are regularly based, and from which a substantial role in the entity's performance of a commercially useful function or a substantial part of its operations is conducted. A location utilized solely as a post office box, mail drop or telephone message center or any combination thereof, with no other substantial work function, shall not be construed as a principal place of business.

E. Headquartered means the location where an entity's leadership directs, controls, and coordinates the entity's activities.

F. Local Preference may be appropriate for contracts related to:

(a) any activity or matter incidental to the advertising, development, or promotion of the Port district or its ports, waterways, harbors, or terminals;

(b) furthering the general welfare of the Port district and its facilities; or

(c) the betterment of the Port district's relations with steamship and rail lines, shippers, consignees of freight, governmental officials, or others interested or sought to be interested in the ports, waterways, harbors, or terminals.

SECTION 7. Historically Underutilized Businesses (HUB).

A. A business submitting a bid under the HUB category for a Port project must obtain a HUB Certification from the State of Texas prior to submission.

B. To be eligible for HUB certification in the State of Texas, a business must:

(1) Be a U.S. citizen;

(2) Be a for-profit entity that has not exceeded the size standard prescribed by 34 TAC §20.294 and has its principal place of business in Texas; and

(3) Be at least 51% owned by an Asian Pacific American, Black American, Hispanic American, Native American, American woman and/or a Service Disabled Veteran with a Service related disability of 20% or greater, who resides in Texas and actively participates in the control, operations and management of the entity's affairs.

SECTION 8. Veteran Owned Businesses.

A. A business submitting a bid under the Veteran Owned business category for a Port project must complete a Veteran Owned business certification packet from the Port prior to submission.

B. A Veteran Owned business must be at least 51% owned by one or more veterans as defined in 38 USC 101(2).

SECTION 9. Program Evaluation and Audit.

A. The Executive Director or his or her designee shall periodically monitor and report benchmarks and metrics to evaluate the Port's Diversity in Contracting Program, including:

(1) Incorporation of these MVW goals into the Port's procurement policies and plans to the fullest extent reasonable, including incorporation into scorecards, reports, and project plan updates.

(2) Specific measures the Port will undertake to increase the participation of MVW firms and to reduce disparities, including the number of events or outreach activities conducted to ensure responsiveness to bid opportunities.

(3) Progress towards specific department MVW utilization goals, including the number of opportunities a department has available, the goals established for those opportunities and the actual utilization, including periodic review of disparity study results, to determine reasonableness of goals.

(4) Data reporting using the standard procedure identified in the MVW program for the Port-wide collection and reporting of relevant demographic data including percent of project dollars spent, number of businesses, and types of procurements.

(5) Preparation and publication of the Port's Diversity in Contracting Annual Report.

B. The Port's Director of Accounting shall include the Diversity in Contracting Program in the Port's annual business plan to monitor and report on adherence to this policy and establish compliance measures for future years as the Director of Accounting deems appropriate.

SECTION 10. Fiscal Implications.

Fiscal implications shall be reviewed by the Executive Director annually, at a minimum, to ensure that implementation of this policy directive is adequately resourced and shall submit a budget request as appropriate.

SECTION K
MISCELLANEOUS DOCUMENTS

MISCELLANEOUS DOCUMENTS

The documents listed below are required to be submitted as detailed in the Instructions to Bidders Submission Format.

- **Conflict of Interest Questionnaire**
- **Energy Companies – Non-Boycott Certification**
- **Firearm Entity/Trade Association – Anti-Discrimination Form**
- **Israel – Non-Boycott Certification**
- **Texas Government Code Chapter 552 Subchapter J, Section 2252.152 & 2252.153 Certification.**

CONFLICT OF INTEREST QUESTIONNAIRE

For vendor doing business with local governmental entity

FORM CIQ

This questionnaire reflects changes made to the law by H.B. 23, 84th Leg., Regular Session.

This questionnaire is being filed in accordance with Chapter 176, Local Government Code, by a vendor who has a business relationship as defined by Section 176.001(1-a) with a local governmental entity and the vendor meets requirements under Section 176.006(a).

By law this questionnaire must be filed with the records administrator of the local governmental entity not later than the 7th business day after the date the vendor becomes aware of facts that require the statement to be filed. See Section 176.006(a-1), Local Government Code.

A vendor commits an offense if the vendor knowingly violates Section 176.006, Local Government Code. An offense under this section is a misdemeanor.

OFFICE USE ONLY

Date Received

1 Name of vendor who has a business relationship with local governmental entity.

2 Check this box if you are filing an update to a previously filed questionnaire. (The law requires that you file an updated completed questionnaire with the appropriate filing authority not later than the 7th business day after the date on which you became aware that the originally filed questionnaire was incomplete or inaccurate.)

3 Name of local government officer about whom the information is being disclosed.

Name of Officer

4 Describe each employment or other business relationship with the local government officer, or a family member of the officer, as described by Section 176.003(a)(2)(A). Also describe any family relationship with the local government officer. Complete subparts A and B for each employment or business relationship described. Attach additional pages to this Form CIQ as necessary.

A. Is the local government officer or a family member of the officer receiving or likely to receive taxable income, other than investment income, from the vendor?

Yes No

B. Is the vendor receiving or likely to receive taxable income, other than investment income, from or at the direction of the local government officer or a family member of the officer AND the taxable income is not received from the local governmental entity?

Yes No

5 Describe each employment or business relationship that the vendor named in Section 1 maintains with a corporation or other business entity with respect to which the local government officer serves as an officer or director, or holds an ownership interest of one percent or more.

6 Check this box if the vendor has given the local government officer or a family member of the officer one or more gifts as described in Section 176.003(a)(2)(B), excluding gifts described in Section 176.003(a-1).

7

Signature of vendor doing business with the governmental entity

Date

CONFLICT OF INTEREST QUESTIONNAIRE

For vendor doing business with local governmental entity

A complete copy of Chapter 176 of the Local Government Code may be found at <http://www.statutes.legis.state.tx.us/Docs/LG/htm/LG.176.htm>. For easy reference, below are some of the sections cited on this form.

Local Government Code § 176.001(1-a): "Business relationship" means a connection between two or more parties based on commercial activity of one of the parties. The term does not include a connection based on:

- (A) a transaction that is subject to rate or fee regulation by a federal, state, or local governmental entity or an agency of a federal, state, or local governmental entity;
- (B) a transaction conducted at a price and subject to terms available to the public; or
- (C) a purchase or lease of goods or services from a person that is chartered by a state or federal agency and that is subject to regular examination by, and reporting to, that agency.

Local Government Code § 176.003(a)(2)(A) and (B):

(a) A local government officer shall file a conflicts disclosure statement with respect to a vendor if:

(2) the vendor:

(A) has an employment or other business relationship with the local government officer or a family member of the officer that results in the officer or family member receiving taxable income, other than investment income, that exceeds \$2,500 during the 12-month period preceding the date that the officer becomes aware that

(i) a contract between the local governmental entity and vendor has been executed;
or

(ii) the local governmental entity is considering entering into a contract with the vendor;

(B) has given to the local government officer or a family member of the officer one or more gifts that have an aggregate value of more than \$100 in the 12-month period preceding the date the officer becomes aware that:

(i) a contract between the local governmental entity and vendor has been executed; or

(ii) the local governmental entity is considering entering into a contract with the vendor.

Local Government Code § 176.006(a) and (a-1)

(a) A vendor shall file a completed conflict of interest questionnaire if the vendor has a business relationship with a local governmental entity and:

(1) has an employment or other business relationship with a local government officer of that local governmental entity, or a family member of the officer, described by Section 176.003(a)(2)(A);

(2) has given a local government officer of that local governmental entity, or a family member of the officer, one or more gifts with the aggregate value specified by Section 176.003(a)(2)(B), excluding any gift described by Section 176.003(a-1); or

(3) has a family relationship with a local government officer of that local governmental entity.

(a-1) The completed conflict of interest questionnaire must be filed with the appropriate records administrator not later than the seventh business day after the later of:

(1) the date that the vendor:

(A) begins discussions or negotiations to enter into a contract with the local governmental entity; or

(B) submits to the local governmental entity an application, response to a request for proposals or bids, correspondence, or another writing related to a potential contract with the local governmental entity; or

(2) the date the vendor becomes aware:

(A) of an employment or other business relationship with a local government officer, or a family member of the officer, described by Subsection (a);

(B) that the vendor has given one or more gifts described by Subsection (a); or

(C) of a family relationship with a local government officer.

CERTIFICATION REQUIRED BY TEXAS GOVERNMENT CODE §2276.002

State law requires certification from a Company for contracts involving goods or services: (1) between a government entity and a Company with 10 or more full-time employees, and (2) has a value of \$100,000 or more that is to be paid wholly or partly from public funds of the governmental entity.

The following definitions apply to this state statute:

1. "Boycott energy company" means, without an ordinary business purpose, refusing to deal with, terminating business activities with, or otherwise taking any action that is intended to penalize, inflict economic harm on, or limit commercial relations with a company because the company:
 - (A) engages in the exploration, production, utilization, transportation, sale, or manufacturing of fossil fuel-based energy and does not commit or pledge to meet environmental standards beyond applicable federal and state law; or
 - (B) does business with a company described by Paragraph (A).
2. "Company" means a for-profit sole proprietorship, organization, association, corporation, partnership, joint venture, limited partnership, limited liability partnership, or limited liability company, including a wholly owned subsidiary, majority-owned subsidiary, parent company, or affiliate of those entities or business associations, that exists to make a profit.

1. By signing below, Company hereby certifies the following:

- (A) does not boycott energy companies; and
- (B) will not boycott energy companies during the term of the contract.

Printed Company Name: _____

Signed by: _____

Printed Name/Title: _____

Dated: _____

OR

2. Alternatively, by signing below, Company hereby certifies that Section 2276.002 does not apply to this contract due to the following (check all that apply):

- Company has fewer than 10 full-time employees; or
- Contract value is for less than \$100,000.00.

Printed Company Name: _____

Signed by: _____

Printed Name/Title: _____

Dated: _____

CERTIFICATION REQUIRED BY TEXAS GOVERNMENT CODE §2274.002

State law requires certification from a Company for contracts involving goods or services: (1) between a government entity and a Company with 10 or more full-time employees, and (2) has a value of \$100,000 or more that is to be paid wholly or partly from public funds of the governmental entity.

The following definitions apply to this state statute:

1. “Discriminate against a firearm entity or firearm trade association”:
 - (A) means, with respect to the entity or association, to:
 - (i) refuse to engage in the trade of any goods or services with the entity or association based solely on its status as a firearm entity or firearm trade association;
 - (ii) refrain from continuing an existing business relationship with the entity or association based solely on its status as a firearm entity or firearm trade association; or
 - (iii) terminate an existing business relationship with the entity or association based solely on its status as a firearm entity or firearm trade association; and
 - (B) does not include:
 - (i) the established policies of a merchant, retail seller, or platform that restrict or prohibit the listing or selling of ammunition, firearms, or firearm accessories; and
 - (ii) a company’s refusal to engage in the trade of any goods or services, decision to refrain from continuing an existing business relationship, or decision to terminate an existing business relationship:
 - (aa) to comply with federal, state, or local law, policy, or regulations or a directive by a regulatory agency; or
 - (bb) for any traditional business reason that is specific to the customer or potential customer and not based solely on an entity’s or association’s status as a firearm entity or firearm trade association.
2. “Company” means a for-profit organization, association, corporation, partnership, joint venture, limited partnership, limited liability partnership, or limited liability company, including a wholly owned subsidiary, majority-owned subsidiary, parent company, or affiliate of those entities or associations that exists to make a profit. The term does not include a sole proprietorship.

1. By signing below, Company hereby certifies the following:

- (A) does not have a practice, policy, guidance, or directive that discriminates against a firearm entity or firearm trade association; and
- (B) will not discriminate during the term of the contract against a firearm entity or firearm trade association.

Printed Company Name: _____

Signed by: _____

Printed Name/Title: _____

Dated: _____

OR

2. Alternatively, by signing below, Company hereby certifies that Section 2274.002 does not apply to this contract due to the following (check all that apply):

- Company is a sole proprietor; or
- Company has fewer than 10 full-time employees; or
- Contract value is for less than \$100,000.00.

Printed Company Name: _____

Signed by: _____

Printed Name/Title: _____

Dated: _____

CERTIFICATION REQUIRED BY TEXAS GOVERNMENT CODE §2271.002

State law requires certification from a Company for contracts involving goods or services: (1) between a government entity and a Company with 10 or more full-time employees, and (2) has a value of \$100,000 or more that is to be paid wholly or partly from public funds of the governmental entity.

The following definitions apply to this state statute:

1. "Boycott Israel" means refusing to deal with, terminating business activities with, or otherwise taking any action that is intended to penalize, inflict economic harm on, or limit commercial relations specifically with Israel, or with a person or entity doing business in Israel or in an Israeli-controlled territory, but does not include an action made for ordinary business purposes; and
2. "Company" means a for-profit organization, association, corporation, partnership, joint venture, limited partnership, limited liability partnership, or limited liability company, including a wholly owned subsidiary, majority-owned subsidiary, parent company, or affiliate of those entities or business associations that exists to make a profit.

1. By signing below, Company hereby certifies the following:

- A. Company does not boycott Israel; and
- B. Company will not boycott Israel during the term of the contract.

Printed Company Name: _____

Signed by: _____

Printed Name/Title: _____

Dated: _____

OR

2. Alternatively, by signing below, Company hereby certifies that Section 2271.002 does not apply to this contract due to the following (check all that apply):

- Company is a sole proprietor; or
- Company has fewer than 10 full-time employees; or
- Contract value is for less than \$100,000.00.

Printed Company Name: _____

Signed by: _____

Printed Name/Title: _____

Dated: _____

CERTIFICATIONS REQUIRED BY TEXAS LAW

By signing below, Contractor hereby certifies that:

1. Texas Government Code Chapter 552, Subchapter J may apply to this solicitation or contract and agrees that the contract may be terminated if Contractor knowingly or intentionally fails to comply with a requirement of that subchapter.
2. Pursuant to Texas Government Code Section 2252.152, it does not engage in business with Iran, Sudan, or foreign terrorist organizations.
3. It is not identified on a list of companies known to have contracts with or provide supplies or services to a foreign terrorist organization prepared and maintained pursuant to Section 2252.153 of the Texas Government Code.

Printed Company Name: _____

Signed by: _____

Printed Name/Title: _____

Dated: _____

SECTION L
DRAWINGS / SPECIFICATIONS

PORT OF PORT ARTHUR NAVIGATION DISTRICT

CONSTRUCTION OF SEAFARER PARKING LOT EXPANSION

PORT COMMISSIONERS
 JOHN A. COMEAUX, PRESIDENT
 RANDY T. MARTIN, VICE PRESIDENT
 LINDA TURNER SPEARS, SECRETARY/ TREASURER
 RAYMOND C. JOHNSON, COMMISSIONER
 MARY WYCOFF, COMMISSIONER
 LARRY A. KELLEY, PORT DIRECTOR/CEO



APPROVED
 PORT OF PORT ARTHUR
 BY: 
 LARRY A. KELLEY
 PORT DIRECTOR / CEO

4/17/2024
 DATE

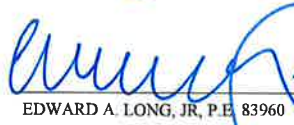
BY: 
 EDWARD A. LONG, JR., P.E. 83960

4/17/2024
 DATE

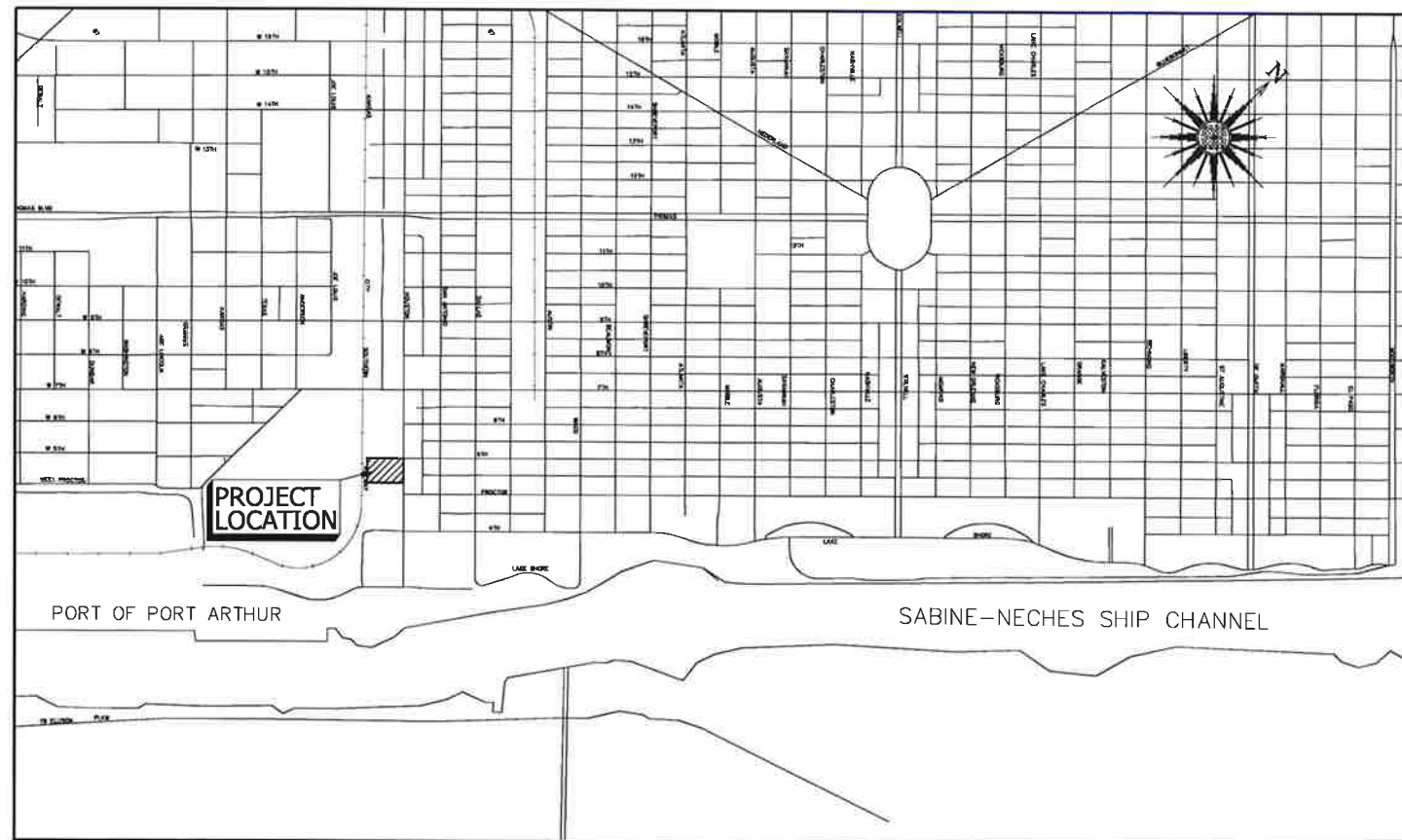

INDEX OF SHEETS

SHEET NO.	DESCRIPTION
1	COVER SHEET
2	GENERAL INFORMATION
3	DEMOLITION PLAN
4	PAVING LAYOUT AND EROSION CONTROL
5	DETAILS
6	SW3P INDEX
7	STRIPING PLAN
8	ENLARGED STRIPING PLAN
9	ECl-16
10	TAS-1

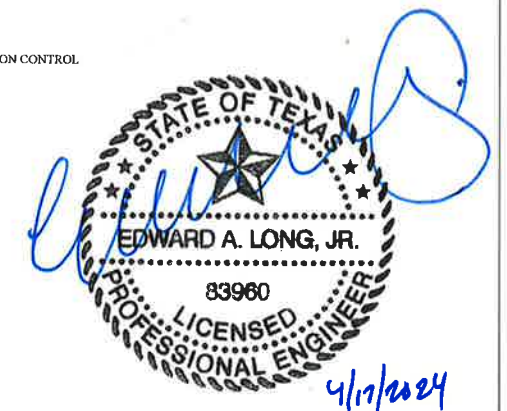

	401 HOUSTON AVE PORT ARTHUR, TX 77642 SEAFARER PARKING LOT EXPANSION PROJECT	
	DATE:	4/15/24
	SCALE:	N.T.S.
	SHEET:	COVER SHEET
SHEET #:		1 OF 10

GENERAL CONSTRUCTION NOTES

1. ALL ELEVATIONS SHOWN ARE NAVD88 DATUM.
2. CONTRACTOR TO VERIFY LOCATION AND ELEVATION OF EXISTING FACILITIES PRIOR TO CONSTRUCTION OF PROPOSED FACILITIES.
3. EXCAVATED MATERIAL TO BE HAULED OFF-SITE.
4. CONCRETE, ASPHALT AND OTHER DEBRIS FOUND DURING CONSTRUCTION SHALL BE DISPOSED OFFSITE BY CONTRACTOR AT NO ADDITIONAL PAY.
5. ALL AREAS DISTURBED BY CONSTRUCTION ACTIVITY SHALL BE RESTORED TO AN EQUAL OR BETTER CONDITION AT THE EXPENSE OF THE CONTRACTOR.
6. ALL PROPOSED CONSTRUCTION WILL BE PERFORMED WITHIN THE BOUNDARY OF PORT ARTHUR INTERNATIONAL SEAFARER CENTER PROPERTY.
7. EXISTING UTILITIES AND OTHER OBSTRUCTIONS ARE SHOWN FOR INFORMATIONAL PURPOSES ONLY. THE ENGINEER AND THE OWNER ASSUME NO RESPONSIBILITY FOR VARIATION IN LOCATION AND GRADES. CONTRACTOR SHALL VERIFY LOCATION AND ELEVATION OF EXISTING FACILITIES PRIOR TO CONSTRUCTION OF PROPOSED FACILITIES. DISCREPANCIES BETWEEN THE TWO SHALL BE IMMEDIATELY REPORTED TO THE OWNER OR ENGINEER.
8. THE CONTRACTOR SHALL SCHEDULE WORK IN A MANNER THAT WILL CAUSE MINIMUM INTERFERENCE WITH TRAFFIC AND TO THE GENERAL PUBLIC. CONTRACTOR SHALL TAKE PROTECTIVE MEASURES TO PREVENT DUST FROM CONSTRUCTION MATERIALS BLOWING ONTO THE ADJACENT PROPERTIES, BUILDINGS AND TO THE GENERAL PUBLIC. CONTRACTOR MAY HAVE TO DELAY CERTAIN OPERATIONS DURING HIGH WIND CONDITIONS.
9. ALL MUD AND DEBRIS SHALL BE REMOVED FROM THE ROADWAYS AT THE END OF EACH WORKDAY AS A MINIMUM.
10. CONTRACTOR SHALL FURNISH, ERECT, AND MAINTAIN ALL BARRICADES, WARNING SIGNS, AND MARKINGS FOR HAZARDS NECESSARY TO PROTECT THE PUBLIC AND THE WORK SITE. WHEN USED DURING PERIODS OF DARKNESS, SUCH BARRICADES, WARNING SIGNS, AND HAZARD MARKINGS SHALL BE SUITABLY ILLUMINATED.
11. AT A MINIMUM, ONE COMPLETE SET OF CONSTRUCTION PLANS AND SPECIFICATIONS SHALL BE MAINTAINED ON-SITE AT ALL TIMES.
12. CONTRACTOR WILL BE RESPONSIBLE FOR CONTACTING ALL UTILITY COMPANIES PRIOR TO CONSTRUCTION IN AREA OF POSSIBLE UNDERGROUND UTILITIES WHICH MAY NOT BE SHOWN ON DRAWING.

COMPANY	CONTACT	PHONE NUMBER
PORT OF PORT ARTHUR CONSTRUCTION & MAINTENANCE COORDINATOR.	MIKE GREEN	(409) 242-8934
PORT ARTHUR INTERNATIONAL SEAFARER CENTER	DOREEN BADEAUX	(409) 982-4504
JEFFERSON COUNTY DRAINAGE DISTRICT NO. 7	BRADY GIROUARD, RPLS	(409) 985-4369
TEXAS GAS SERVICE	ART THOMAS	(512) 571-1941
ENTERGY	DASHAUN ARMSTRONG	(409) 785-2412
AT&T (SWBT)	RAY HILLIN	(409) 291-9757
TIME WARNER COMMUNICATIONS (TCI)	JASON WHITLEY	(409) 720-5520
CITY OF PORT ARTHUR PUBLIC WORKS	FLOZELLE ROBERTS	(409) 983-8511
CITY OF PORT ARTHUR DISPATCH (WATER & SEWER)		(409) 983-8550
TEXAS ONE CALL SYSTEM	WWW.TEXASB11.ORG	DIAL 811

SITE STABILIZATION CONSTRUCTION NOTES

1. ALL SUBGRADE SHALL BE PROOFROLLED IN ACCORDANCE WITH TxDOT 2004 STANDARD SPECIFICATION ITEM 210. ANY SOFT AREAS FOUND SHALL BE EXCAVATED AND BACKFILLED WITH AN APPROVED FILL MATERIAL AND COMPACTED TO 95% OF THE STANDARD PROCTOR DENSITY.
2. INSTALL 6" OF SELECT FILL AND COMPACT TO 95% OF THE STANDARD PROCTOR DENSITY. SELECT FILL SHALL HAVE A PLASTICITY INDEX (PI) LESS THAN 20.
3. ALL CONCRETE SHALL HAVE A MINIMUM COMPRESSIVE STRENGTH OF 4000 PSI AT 28 DAYS AND SHALL HAVE A MINIMUM OF FIVE (5) SACKS OF CEMENT.
4. ALL CONCRETE DRIVEWAYS AND MANHOLE APRONS TO HAVE A MINIMUM COMPRESSIVE STRENGTH OF 4000 PSI AT 28 DAYS.
5. ALL JOINTS IN CONCRETE DRIVEWAY, IF ANY, SHALL BE SEALED WITH A POLYURETHANE SEALANT OR APPROVED EQUAL.
6. REMOVAL OF CONCRETE PAVEMENT AND CURB, AS REQUIRED TO CONSTRUCT PROPOSED DRIVEWAYS SHALL BE PAID FOR AS LUMP SUM COST FOR DEMOLITION.

STORMWATER POLLUTION PREVENTION PLAN

1. THE TOTAL PROJECT AREA THAT WILL BE DISTURBED IS LESS THAN 1 ACRE. DUE TO THE SIZE OF THE PROJECT, THE CONTRACTOR SHALL:
 - A) UTILIZE BEST MANAGEMENT PRACTICES.
 - B) SUBMIT A COPY OF THE SITE NOTICE TO THE MS4 OPERATOR (CITY OF PORT ARTHUR)
 - C) MAINTAIN A SW3P PLAN

SUPPLEMENTAL NOTES TO SPECIFICATIONS

1. THE CONTRACTOR SHALL FURNISH ALL LINES, GRADES AND BENCH MARKS.
2. THE OWNER'S TESTING AGENCY WILL PROVIDE QUALITY CONTROL ON THE CONSTRUCTION MATERIALS AND METHODS.



	401 HOUSTON AVE PORT ARTHUR, TX 77642 SEAFARER PARKING LOT EXPANSION PROJECT	
	DATE:	4/15/24
	SCALE:	N.T.S.
	SHEET:	GENERAL INFO
	SHEET #:	2 OF 10

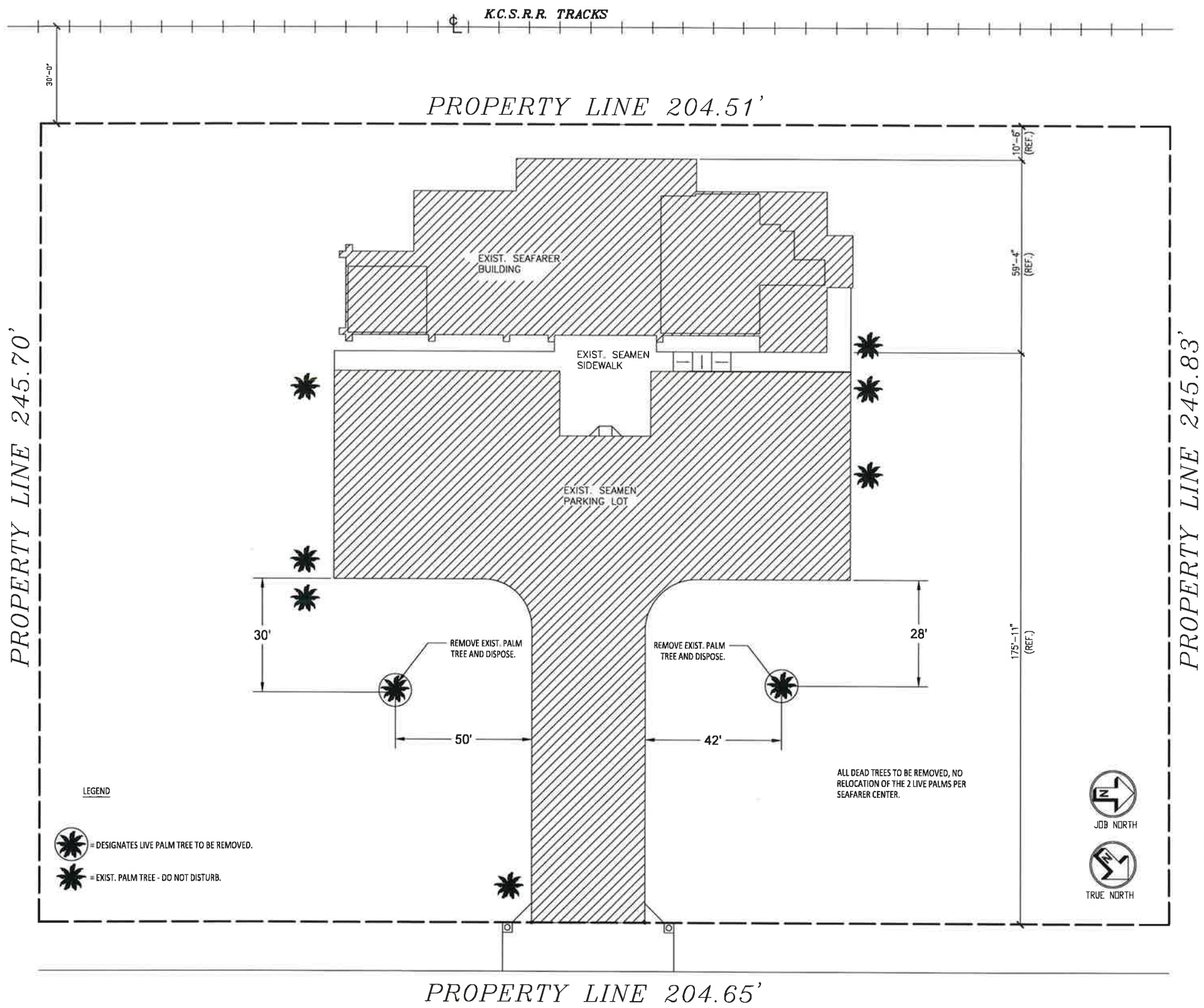

PROPERTY LINE 204.65'

PALM TREE PLAN
SCALE: 1/16"=1'-0"
HOUSTON AVE.
(100' R.O.W.)

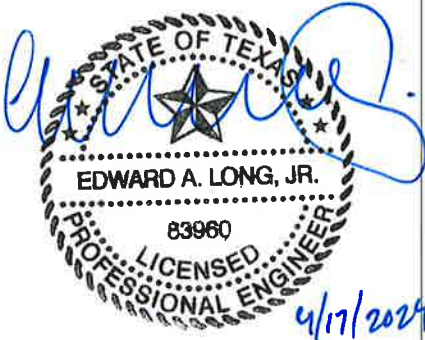

	401 HOUSTON AVE PORT ARTHUR, TX 77642 SEAFARER PARKING LOT EXPANSION PROJECT	
	DATE:	4/15/24
	SCALE:	N.T.S.
	SHEET:	DEMO PLAN
	SHEET #:	3 OF 10

GENERAL NOTES

1. VERIFY LOCATION OF EXIST. UTILITIES PRIOR TO EXCAVATION.
2. CONTRACTOR TO PROVIDE LAYOUT OF PAVING.
3. CONTACT ENGINEER IF ANY SITE IRREGULARITIES ARE NOTED.
4. CONTRACTOR TO FIELD MATCH EXISTING PAVEMENT.
5. ALL CONCRETE SHALL HAVE A COMPRESSIVE STRENGTH OF 4000 PSI CONCRETE AT 28 DAYS.
6. MINIMUM CEMENT RATIO TO BE: 5 SACKS PER CUBIC YARD FOR 4000 PSI CONCRETE.
7. ALL WELDED WIRE SHALL CONFORM TO ASTM 185.
8. DETAILING FABRICATION AND PLACING OF CONCRETE REINFORCEMENT AND ACCESSORIES SHALL BE IN ACCORDANCE WITH ACI LATEST EDITION. WELDED WIRE FABRIC SHALL LAP SO THAT THE OVERLAP MEASURED BETWEEN OUT MOST CROSS WIRES OF EACH FABRIC SHEET IS NOT LESS THAN THE SPACING OF CROSS WIRES PLUS 2.
9. ALL MIXING, TRANSPORTING, PLACING, AND CURING OF CONCRETE SHALL BE DONE IN ACCORDANCE WITH THE RECOMMENDATION OF THE LATEST EDITION OF THE AMERICAN CONCRETE INSTITUTE ACI 318, ACI 301, ACI 309, ACI 305 AND ACI 306. MAIMUM FREE FALL FOR CONCRETE TO BE 3'-0"

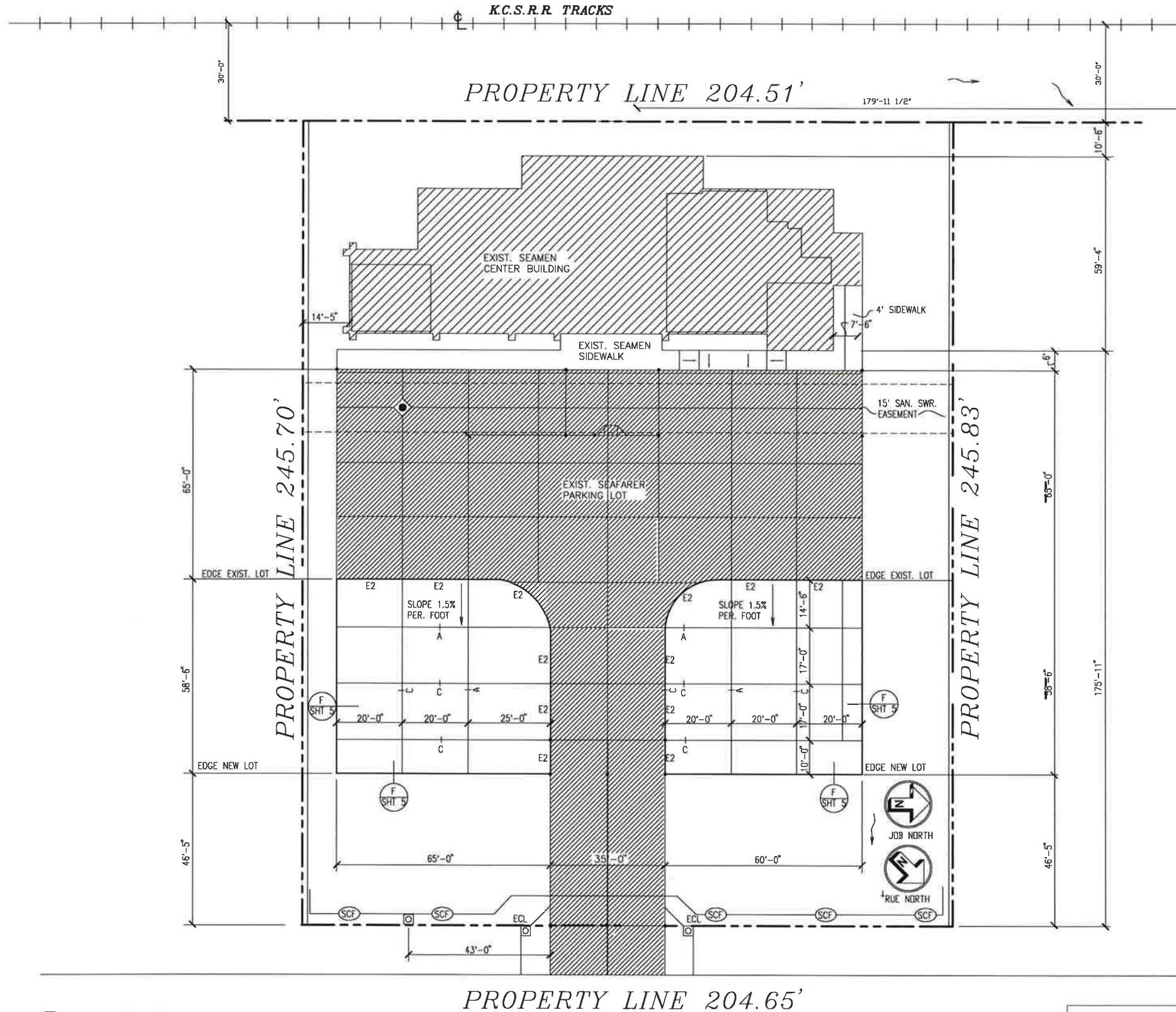

WM = EXIST. WATER METER

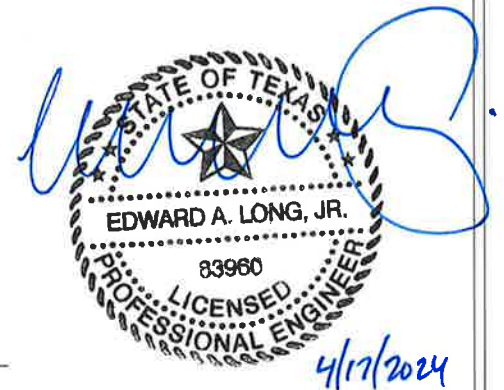

401 HOUSTON AVE
PORT ARTHUR, TX 77642
SEFARER PARKING LOT
EXPANSION PROJECT

DATE:	4/15/24
SCALE:	1/16" = 1'-0"
SHEET:	PAVING LAYOUT
SHEET #:	4 OF 10

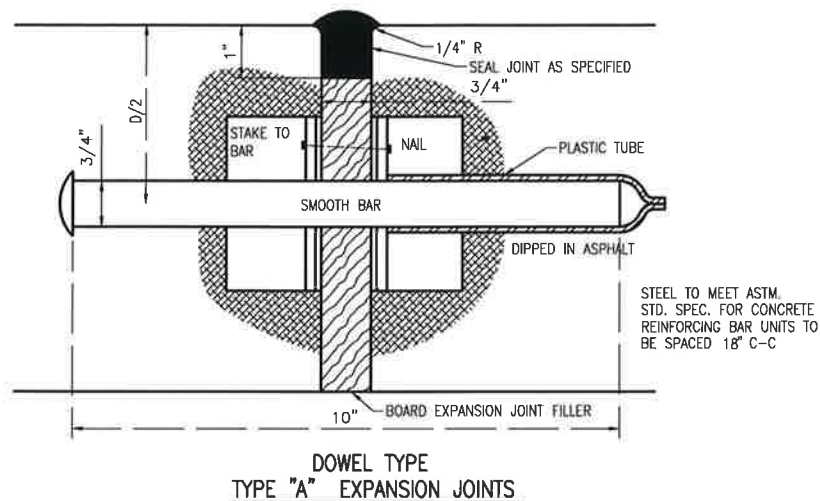

DOWEL TYPE
TYPE "A" EXPANSION JOINTS

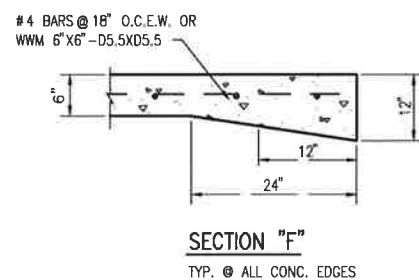

SECTION "F"
TYP. @ ALL CONC. EDGES

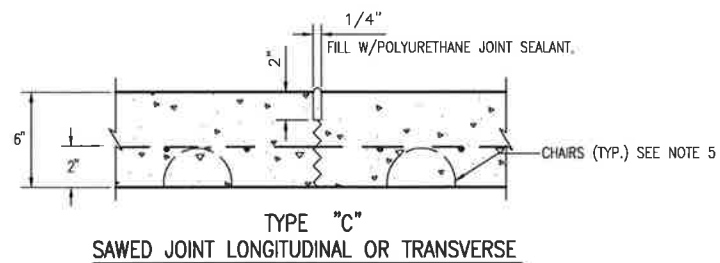

TYPE "C"
SAWED JOINT LONGITUDINAL OR TRANSVERSE

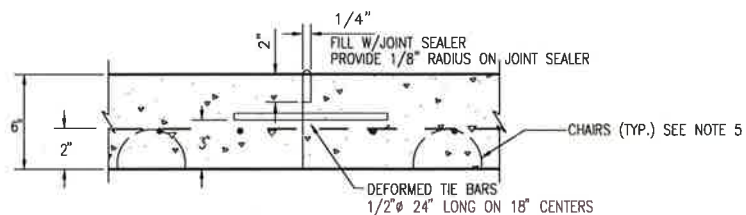

TYPE "E" "E1"
CONSTRUCTION JOINT
(TO BE USED AT END OF DAY OR UNEXPECTED DELAY)

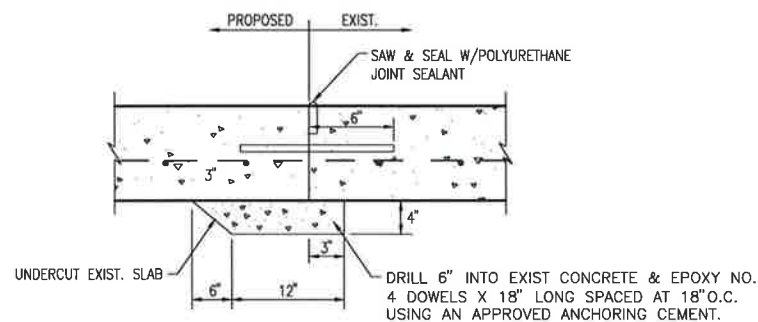

TYPE "E2" JOINT - EXIST. PAVEMENT

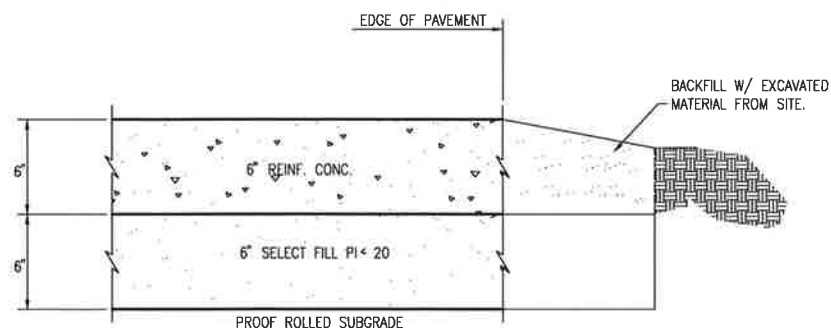

TYPICAL SECTION

GENERAL NOTES:

1. ALL JOINTS EXCEPT EXPANSION JOINTS AND LONGITUDINAL CONSTRUCTION JOINTS IN CONCRETE STREET PAVEMENT SHALL BE SAWED AND SEALED. EXPANSION JOINTS TO BE SEALED AFTER REMOVAL OF CAP STRIP.
2. EXPANSION JOINT TO BE PLACED AT END OF EACH CURB RADIUS AND AT INTERVALS NOT TO EXCEED 60' ON STRAIGHT SECTIONS, EXPANSION JOINT FILLER BOARDS SHALL CONFORM TO TOP OF PROPOSED RIDING SURFACE.
3. USE 1" X 3/4" CONSTRUCTION JOINT CAP STRIP AND REMOVE AFTER NOT LESS THAN 7 DAYS. INSTALL BACKER ROD AND SEAL WITH POLYURETHANE JOINT SEALER.
4. WHEN A JOINT FALLS WITHIN 5' OF OR CONTACT BASINS, MANHOLES, OR OTHER STRUCTURES SHORTEN ONE OR MORE PANELS EITHER SIDE OF OPENING TO PERMIT JOINT TO FALL ON ROUND STRUCTURES AND AT OR BETWEEN CORNER OF RECTANGULAR STRUCTURES.
5. REINFORCING STEEL TO BE PLACED 2" FROM BOTTOM OF SLAB AND SUPPORTED ON CHAIRS WHICH WILL ADEQUATELY SUPPORT IT DURING CONSTRUCTION. TIED STEEL SHALL BE 4 BARS AT 18" O.C.E.W. OR WWM 6"x6"-D5.5 X D5.5. ROLL WIRE NOT ALLOWED.
6. ALL DOWELS USED FOR EXPANSION JOINTS AND CONSTRUCTION JOINTS MUST BE SUPPORTED ADEQUATELY SO THAT THEIR POSITION WILL BE MAINTAINED DURING CONSTRUCTION.
7. CONTRACTOR SHALL PLACE 6" COMPACTED SELECT FILL MATERIAL UNDER ALL CONCRETE PAVEMENT. SELECT FILL SHALL EXTEND A MINIMUM OF 1'-0" FOOT AT ALL CONCRETE EDGES AND PERIMETERS.
8. FILLER BOARDS SHALL BE OF SELECTED STOCK, FREE OF ANY DEFECTS AND OF DENSITY AND OF TYPE WOOD AS INDICATED BELOW.

TYPE OF WOOD	MAX. WEIGHT PER CU. FT. WHEN OVEN DRIED TO A CONSTANT WEIGHT
1. CLEAR, ALL HEART CYPRESS	40 LBS.
2. CLEAR, ALL HEART REDWOOD	30 LBS.



401 HOUSTON AVE
PORT ARTHUR, TX 77642
SEFARER PARKING LOT
EXPANSION PROJECT

DATE: 4/15/24
SCALE: N.T.S.
SHEET: DETAILS
SHEET #: 5 OF 10

SITE DESCRIPTION

Notes:

- The Site Description is accomplished using various sheets, each revealing separate details. This Index Sheet's purpose is to point the user to the appropriate location where the information required by the TPDES CGP can be found.
- The project limits shown on the Title Sheet and limits of Owner's Right Of Way shall also be the limits of coverage of the SW3P.

NATURE OF ACTIVITY: EXPAND EXISTING CONCRETE PARKING LOT.

INTENDED SEQUENCE OF MAJOR SOIL DISTURBING ACTIVITIES: EROSION & SEDIMENT CONTROLS STRIPPING TOP SOIL, SUBGRADE STABILIZATION, INSTALL CONCRETE PAVEMENT, CLEANUP AND FINAL SEEDING.

TOTAL AREA OF SITE: 1.15 AREA TO BE DISTURBED: 0.18

TOTAL AREA OF OVERALL PROJECT (ALL PHASES): 0.18

PRE-CONSTRUCTION RUNOFF CO-EFFICIENT: 0.59

POST-CONSTRUCTION RUNOFF CO-EFFICIENT: 0.68

EXISTING SOIL DESCRIPTION: GROUND COVER CONSIST OF VARIOUS GRASSES, SUBSURFACE SOILS CONSIST OF CLAY.

GENERAL LOCATION MAP: INTERSECTION OF HOUSTON AVENUE AT PROCTOR STREET

RECEIVING WATERS: SEGMENT NUMBER CITY OF PORT ARTHUR STORM SEWER
SEGMENT NAME N/A

LOCATION OF WETLAND OR SPECIAL AQUATIC SITES: DOES NOT APPLY

DRAINAGE PATTERNS: SURFACE RUNOFF INTO PORT ARTHUR STORM SEWERS.

TYPICAL AREAS OF SOIL DISTURBANCE: VEGETATED AREAS TO RECEIVE NEW PAVEMENT.

TYPICAL AREAS WHICH WILL NOT BE DISTURBED: VEGETATED AREAS ALONG PERIMETER OF

LOCATION OF OFF-SITE SURFACE RECEIVING WATERS: SABINE-NECHES WATERWAY VIA HOUSTON AVENUE PUMP STATION.

LOCATIONS WHERE STABILIZATION PRACTICES WILL OCCUR: DOWNSTREAM OF SOIL DISTURBANCE PRIOR TO INLETS.

LOCATIONS OF OFF-SITE STORAGE OF MATERIALS AND EQUIPMENT, WASTE, BORROW, OR DEDICATED MATERIAL PROCESSING PLANTS: NONE AT THIS TIME.

LOCATIONS WHERE STORM WATER DISCHARGES TO SURFACE WATERS: IMMEDIATELY DOWNSTREAM OF DD7 HOUSTON AVENUE PUMP STATION INTO SNWW.

LOCATION OF POLLUTION CONTROL MEASURES: Shall be found on the SW3P Sheets.

CONTROLS

SOIL STABILIZATION PRACTICES

INTERIM:

- | | |
|--|---|
| <input type="checkbox"/> TEMPORARY SEEDING | <input checked="" type="checkbox"/> PRESERVATION OF NATURAL RESOURCES |
| <input type="checkbox"/> MULCHING (Hay or Straw) | <input type="checkbox"/> FLEXIBLE CHANNEL LINER |
| <input type="checkbox"/> BUFFER ZONES | <input type="checkbox"/> OTHER (IMMEDIATE REPLACEMENT OF CONCRETE LINER.) |

PERMANENT:

- | | |
|---|--|
| <input checked="" type="checkbox"/> SEEDING | <input type="checkbox"/> RETENTION BLANKET |
| <input type="checkbox"/> BLOCK SOD | <input type="checkbox"/> CHANNEL LINER |
| <input type="checkbox"/> OTHER | |

STRUCTURAL PRACTICES (T/P)*

- | | |
|--|--|
| <input type="checkbox"/> SILT FENCE | <input type="checkbox"/> PAVED FLUMES |
| <input type="checkbox"/> HAY BALES | <input type="checkbox"/> ROCK BEDDING AT CONSTRUCTION EXIT |
| <input type="checkbox"/> ROCK BERMS | <input type="checkbox"/> TIMBER MATTING AT CONSTRUCTION EXIT |
| <input type="checkbox"/> PIPE SLOPE DRAINS | <input type="checkbox"/> SEDIMENT TRAPS |
| <input type="checkbox"/> CHANNEL LINERS | <input type="checkbox"/> SEDIMENT BASINS |
| <input type="checkbox"/> STORM SEWERS | <input type="checkbox"/> CURB and GUTTER |
| <input type="checkbox"/> STORM INLET SEDIMENT TRAP | <input type="checkbox"/> VELOCITY CONTROL DEVICES |
| <input type="checkbox"/> STONE OUTLET STRUCTURES | |
| <input type="checkbox"/> DIVERSION, INTERCEPTOR, or PERIMETER SWALES | |
| <input type="checkbox"/> DIVERSION, INTERCEPTOR, or PERIMETER DIKES | |

* T means Temporary - P means Permanent

PERMANENT POST CONSTRUCTION TSS CONTROLS

- | |
|--|
| <input type="checkbox"/> RETENTION / IRRIGATION |
| <input type="checkbox"/> EXTENDED DETENTION BASINS |
| <input checked="" type="checkbox"/> VEGETATIVE FILTER STRIPS / VEGETATIVE SWALES |
| <input type="checkbox"/> CONSTRUCTED WETLANDS |
| <input type="checkbox"/> WET BASINS |

OTHER CONTROLS

- | |
|--|
| <input checked="" type="checkbox"/> WATERING FOR DUST CONTROLS |
| <input checked="" type="checkbox"/> SEDIMENT REMOVAL FROM ROADWAY (SWEEPING) |
| <input checked="" type="checkbox"/> LOADED TRUCKS WILL BE COVERED WITH TARP |

The above indicated practices are proposed to control pollutants in storm water discharges. These practices are based on information contained in TxDOT Storm Water Management Guidelines. The Schedule of implementation of these practices will be based on the intended Sequence of Major Soil Disturbing Activities. Stabilization measures shall be initiated no later than 14 days after construction activity of that portion of the site has temporarily or permanently ceased.

Describe construction and waste materials expected to be stored on site and proposed controls to reduce pollutants from these materials (include storage practices spill prevention and response. CONTRACTOR SHALL STORE ALL CONSTRUCTION MATERIALS

IN LOCATIONS WHICH MINIMIZE THE POTENTIAL FOR THE MATERIALS TO ENTER STORM WATER RUNOFF. CONSTRUCTION WASTE MATERIALS SHALL NOT BE BURIED OR DISPOSED OF ON SITE, BUT SHALL BE STORED AND DISPOSED OF IN ACCORDANCE WITH LOCAL, STATE AND FEDERAL REGULATIONS. CONSTRUCTION STAGING AREAS AND VEHICLE MAINTENANCE AREA SHALL BE CONSTRUCTED BY THE CONTRACTOR IN A MANNER TO MINIMIZE THE RUNOFF OF POLLUTANTS.

Describe pollutant sources from areas other than construction and measures implemented at those sites to minimize pollutant discharges. ALL SANITARY WASTE ALL SANITARY WASTE WILL BE COLLECTED FROM PORTABLE UNITS AS NECESSARY OR AS REQUIRED BY LOCAL REGULATIONS BY A LICENSED SANITARY WASTE MANAGEMENT COMPANY.

Describe measures necessary to protect listed endangered or threatened species, or critical habitat. N/A

INFORMATION

MAINTENANCE:

All erosion and sediments control and other protective measures identified in the SW3P must be maintained in effective operating conditions. If site inspections required by this permit identify BMP's that are not operating effectively, maintenance shall be performed before the next anticipated storm event, or as necessary to maintain the continued effectiveness of storm water controls. If no maintenance prior to the next anticipated storm event is unpracticable, maintenance must be scheduled.

INSPECTION:

Qualified personnel shall inspect disturbed areas of the construction site that have not been finally stabilized, areas used for storage of materials that are exposed to precipitation, structural control measures, and locations where vehicles enter or exit the site, at least once every 14 calendar days and within 24 hours of the end of a storm event of 0.5 inches or greater.

- Disturbed areas that are exposed to precipitation shall be inspected for evidence of, or the potential for, pollutants entering the drainage system. Sediment and erosion control measures identified on the SW3P shall be observed to ensure that they are operating correctly. Locations where vehicles enter or exit the site shall be inspected for evidence of offsite sediment tracking. Sediments must be removed from sediment control structures no later than the time that the design capacity has been reduced by 50%.
- Based on the results of the inspection, the SW3P shall be revised to include (show on Site Map) additional or modified BMP's designed to correct the observed deficiency. Revisions to the SW3P must be completed within seven (7) calendar days following the inspection.
- A report summarizing the scope, date, name and qualifications of inspector, and major observations relating to the implementation of the SW3P shall be produced and retained as part of the SW3P for 3 years from date of final stabilization.
- The following records must be maintained and either attached to or referenced in the SW3P, and made readily available upon request to the parties in Part III.D.1 of the CGP: 1). The dates when major grading activities occur; 2). The dates when construction activities temporarily or permanently cease on a portion of the site and; 3). The dates when stabilization measures are initiated.

INSPECTOR PAPERWORK CHECKLIST:

- | |
|--|
| <input type="checkbox"/> Contact Form (1) |
| <input type="checkbox"/> Notice of Intent (1)(2) (NOT REQUIRED DUE TO SIZE OF DISTURBED AREA) |
| <input type="checkbox"/> SW3P Certification Statement (2) |
| <input type="checkbox"/> Delegation of Signature Authority (all Inspectors signing reports) (2)(3) |
| <input type="checkbox"/> TPDES General Permit (2)(3) |
| <input type="checkbox"/> Inspection and Maintenance Report (2)(3) |
| <input type="checkbox"/> Notice of Termination (2) (NOT REQ'D DUE TO SIZE OF DISTURBED AREA) |
| <input type="checkbox"/> SW3P Plan (2)(3) |
| <input type="checkbox"/> Inspector Qualification Form (2)(3) |
| <input type="checkbox"/> Project Diary(2)(3) |
- (1) The information should be displayed on the Project.
(2) The information should be a part of the permanent SW3P file maintained at the Owner's Office.
(3) The information should be maintained at the Field Office.

STORM WATER POLLUTION PREVENTION PLAN is consistent with requirements specified in applicable sediment and erosion site plans or site permits, or storm water management site plans or site permits approved by State, Tribal or local officials (i.e. MS4 Permits).

Any reportable quantity of Hazardous Material release must be reported to the National Response Center at 1-800-424-8802.

A copy of the Construction General Permit is part of the SW3P.



401 HOUSTON AVE PORT ARTHUR, TX 77642	
SEFARER PARKING LOT EXPANSION PROJECT	
DATE:	4/15/24
SCALE:	N.T.S.
SHEET:	SW3P INDEX
SHEET #:	6 OF 10

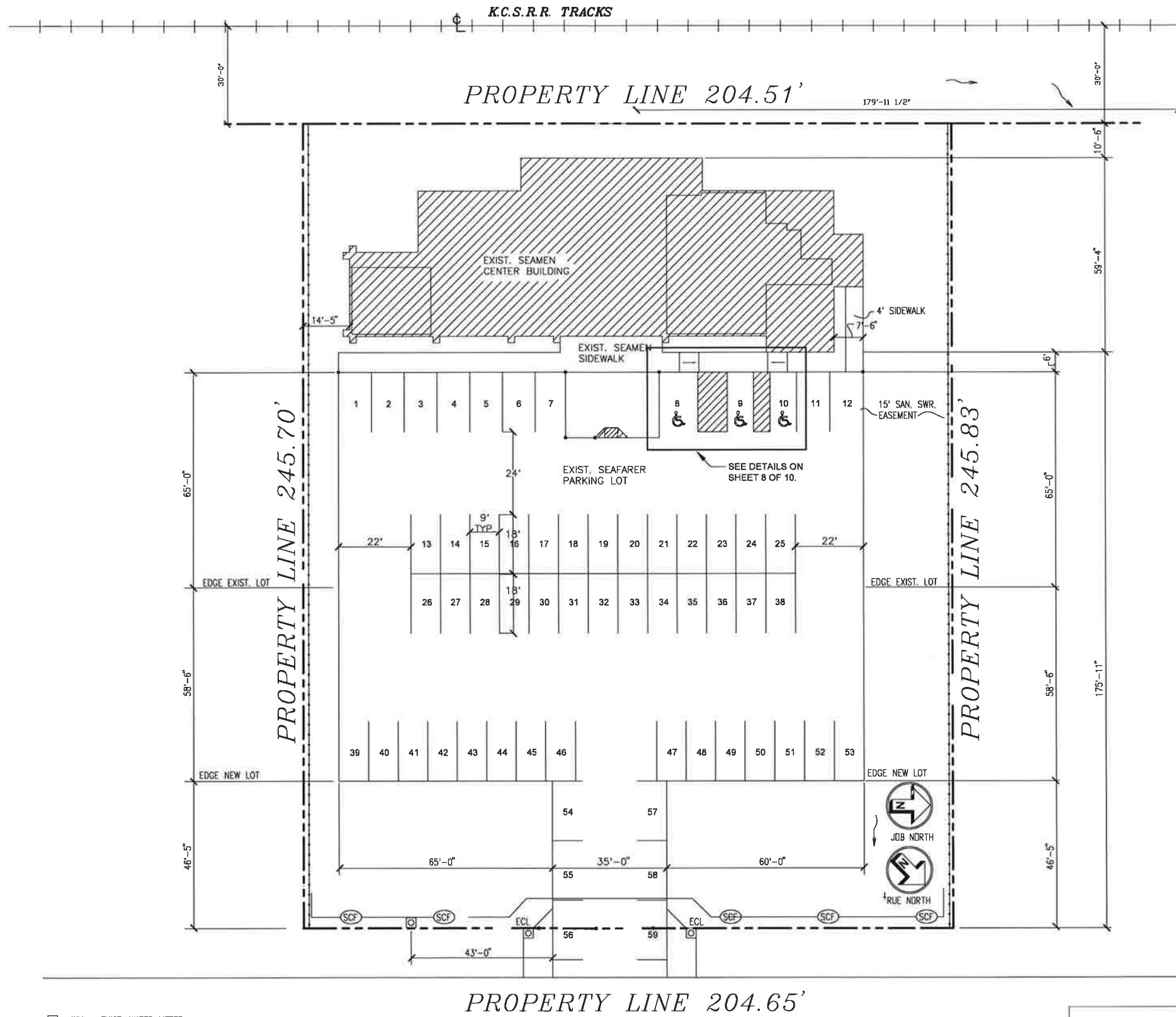

1. PRESSURE WASH PARKING LOT AS REQUIRED FOR NEW PARKING LOT STRIPING/LAYOUT.
2. SIDEWALK RAMPS TO BE IN COMPLIANCE WITH ALL APPLICABLE ADA CODES AND STANDARDS.

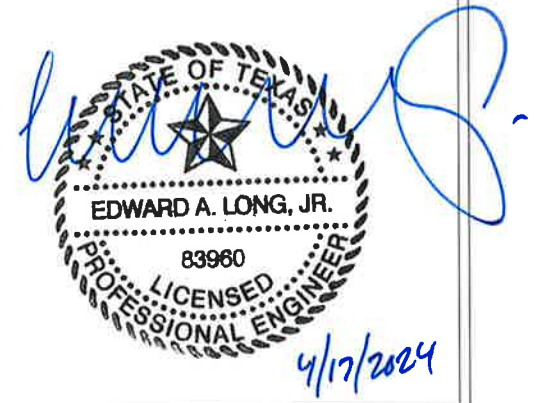

WM = EXIST. WATER METER

PROPERTY LINE 204.65'

PAVEMENT PLAN

SCALE: 1/16" = 1'-0"

HOUSTON AVE.

(100' R.O.W.)



401 HOUSTON AVE
 PORT ARTHUR, TX 77642
 SEFARER PARKING LOT
 EXPANSION PROJECT

DATE:	4/15/24
SCALE:	1/16" = 1'-0"
SHEET:	STRIPING PLAN
SHEET #:	7 OF 10

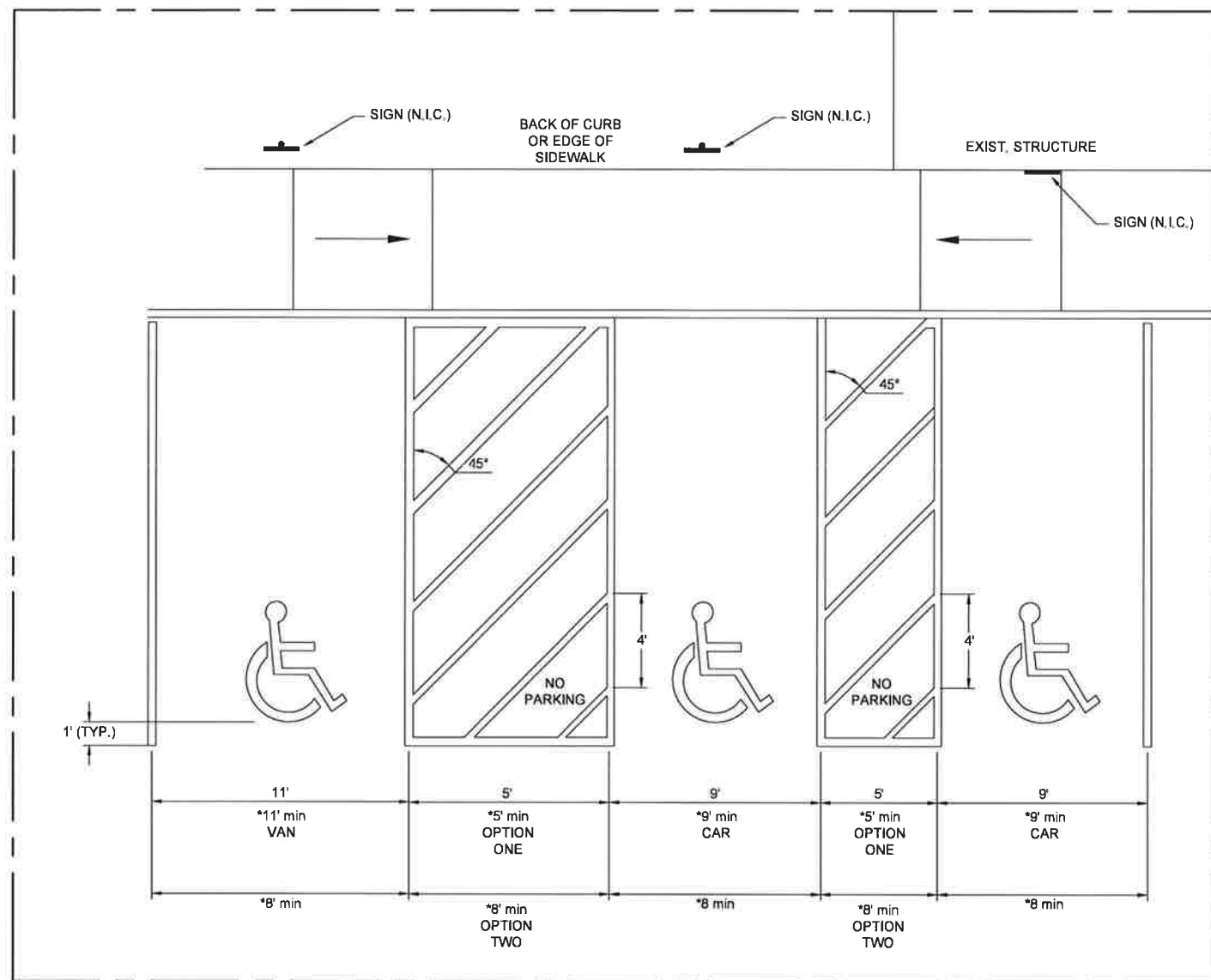

ENLARGED PLAN

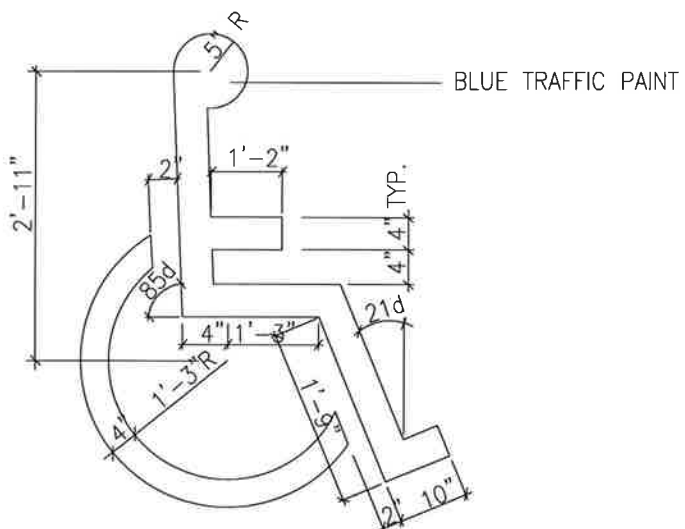

NOTE: SEE SITE PLAN FOR LOCATIONS



	401 HOUSTON AVE PORT ARTHUR, TX 77642 SEFARER PARKING LOT EXPANSION PROJECT	
	DATE:	4/15/24
	SCALE:	1/16" = 1'-0"
	SHEET:	ENLARGED STRIPING PLAN
	SHEET #:	8 OF 10

DISCLAIMER: The use of this standard is governed by the "Texas Engineering Practice Act". No warranty of any kind is made by TxDOT for any purpose whatsoever. TxDOT assumes no responsibility for the conversion of this standard to other formats or for incorrect results or damages resulting from its use.

Connect the ends of the successive reinforcement sheets or rolls a minimum of 6 times with hog rings.

Galvanized welded wire mesh (W.W.M.) (12.5 GA. SWG Min.) with a maximum opening size of 2"x 4" or Woven Mesh (W.M.) (See woven mesh option detail)

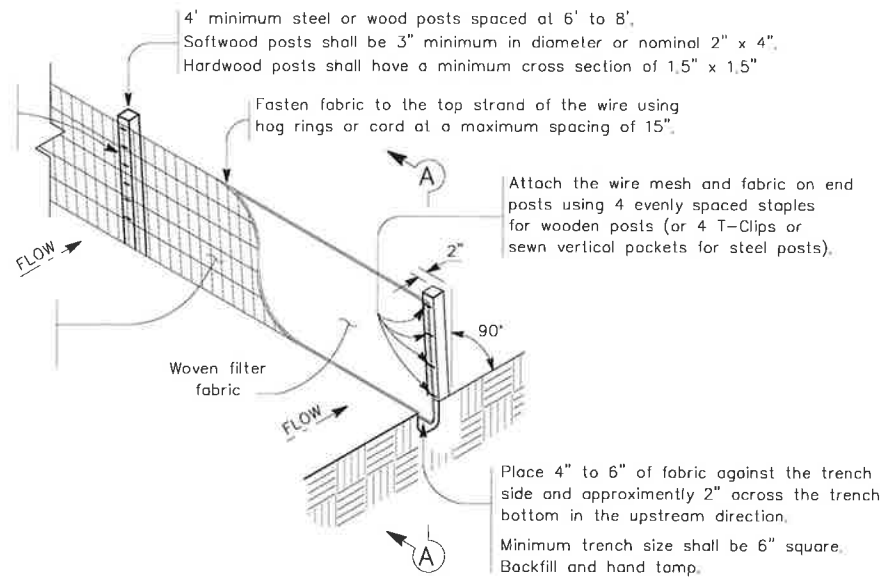

TEMPORARY SEDIMENT CONTROL FENCE



Top of Fence

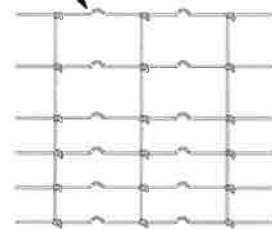

HINGE JOINT KNOT WOVEN MESH (OPTION) DETAIL

Galvanized hinge joint knot woven mesh (12.5 GA. SWG Min.) requires a minimum of five horizontal wires spaced at a maximum of 12 inches apart and all vertical wires spaced at a maximum of 12 inches apart.

Filter fabric 3' min. width.

Backfill & hand tamp.

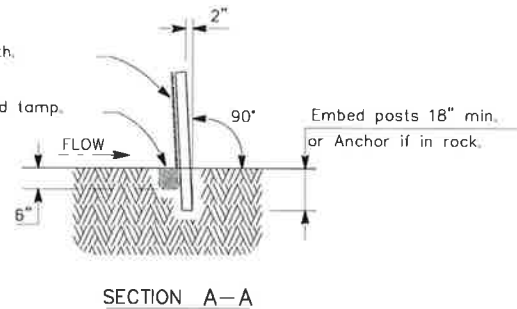

SEDIMENT CONTROL FENCE USAGE GUIDELINES

A sediment control fence may be constructed near the downstream perimeter of a disturbed area along a contour to intercept sediment from overland runoff. A 2 year storm frequency may be used to calculate the flow rate to be filtered.

Sediment control fence should be sized to filter a maximum flow through rate of 100 GPM/FT. ²Sediment control fence is not recommended to control erosion from a drainage area larger than 2 acres.

LEGEND

Sediment Control Fence



Professional Engineer Seal for Edward A. Long, Jr., License No. 83960, dated 4/17/2024.

Texas Department of Transportation		Design Division Standard	
TEMPORARY EROSION, SEDIMENT AND WATER POLLUTION CONTROL MEASURES FENCE & VERTICAL TRACKING			
EC(1)-16			
FILE: ec116	DN: TxDOT	CK: KM	DR: VP
DATE: JULY 2016	CONT: SEC#	JOB:	HIGHWAY:
REVISIONS		DIST:	COUNTY:
		SHEET NO. 9 OF 10	

DATE FILE

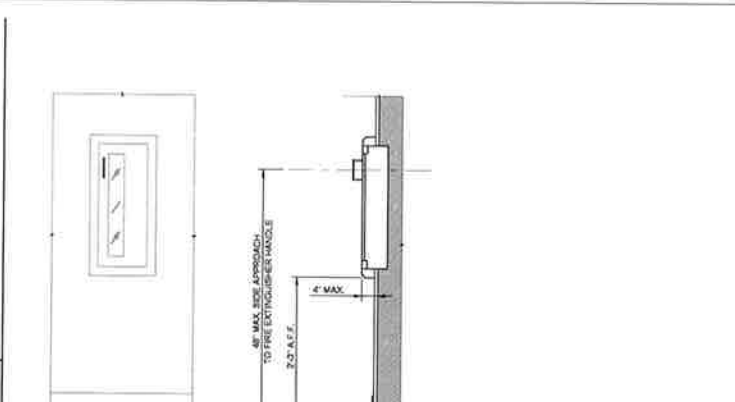
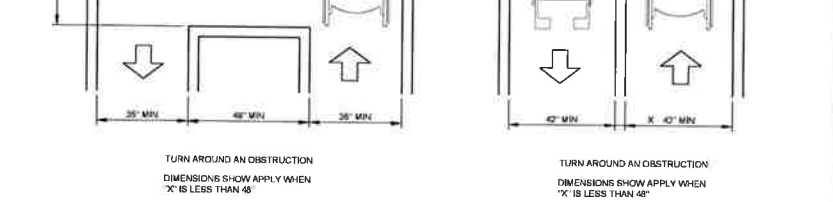
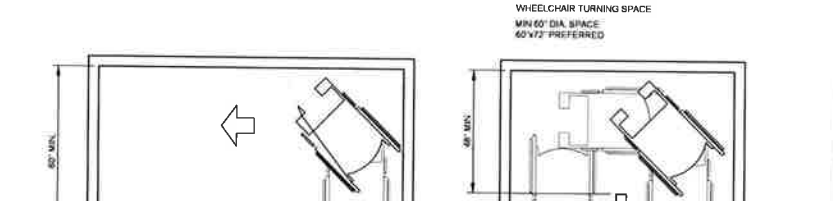
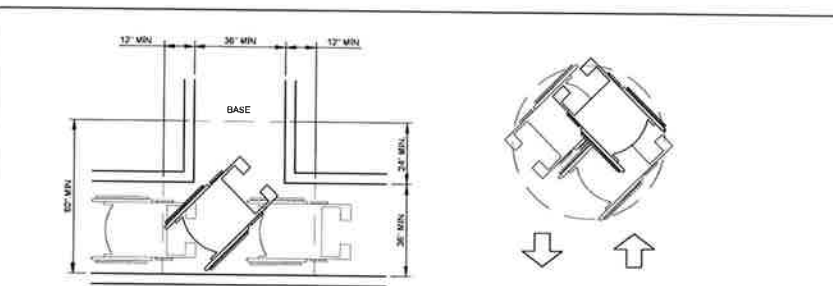
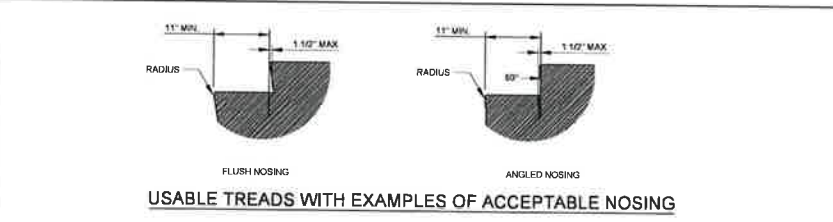
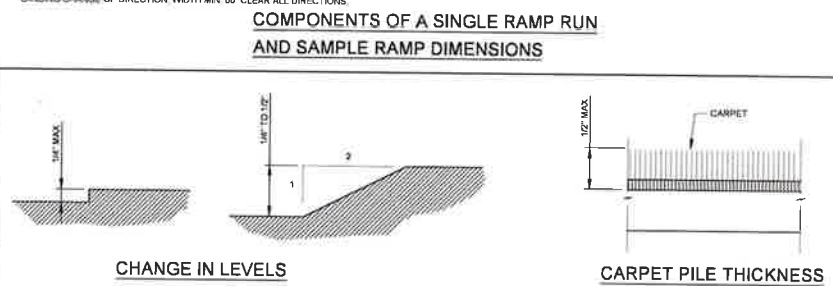
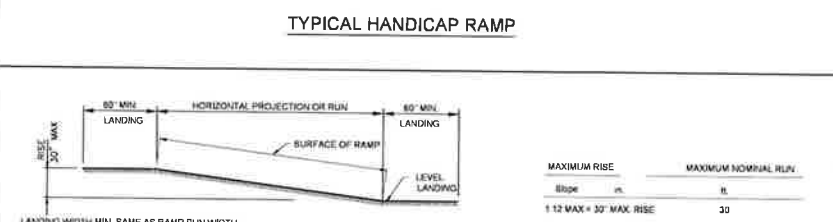
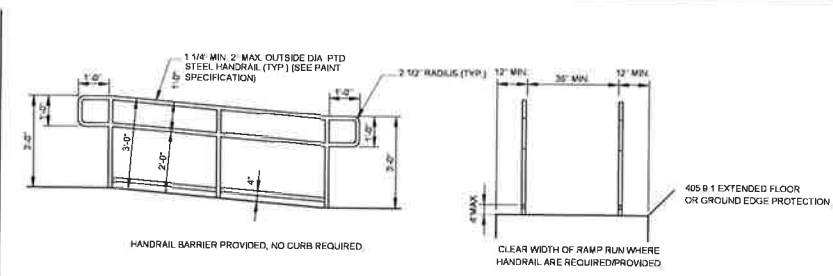
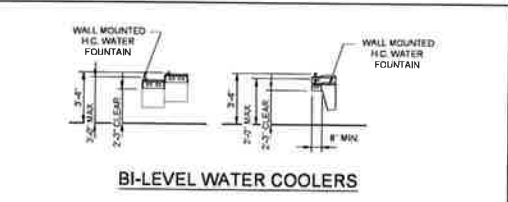
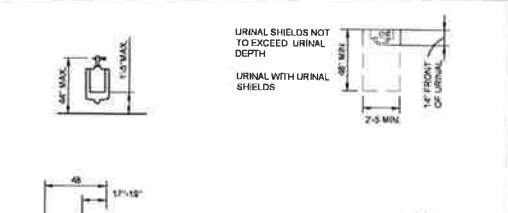
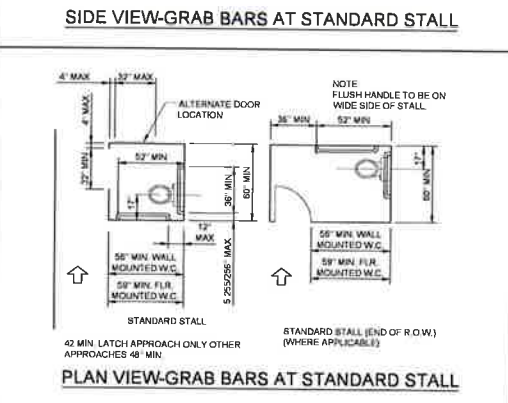
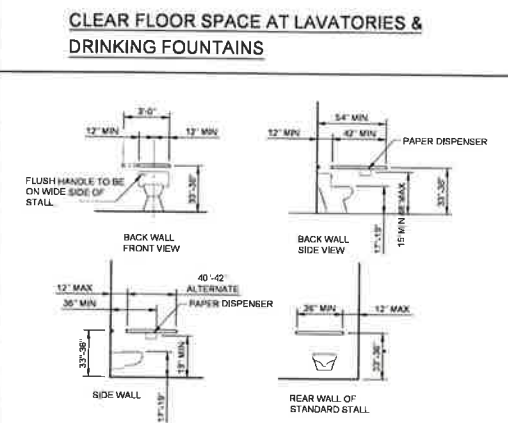
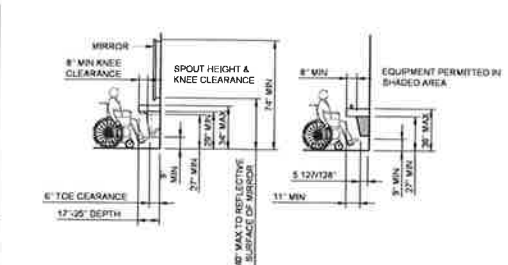
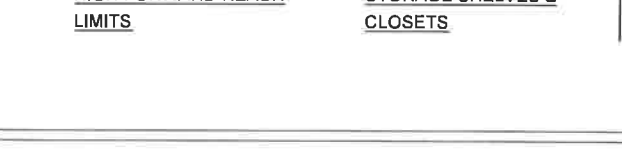
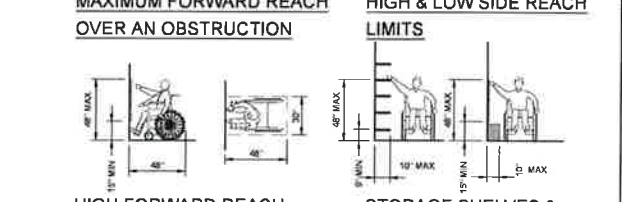
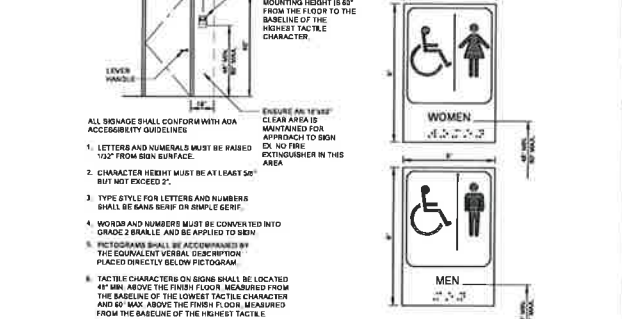
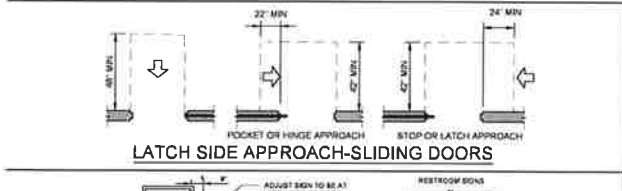
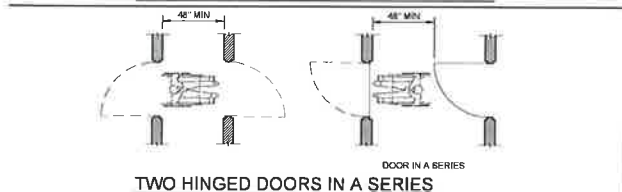
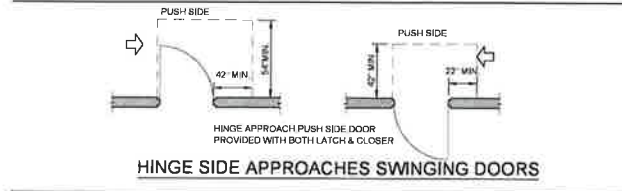
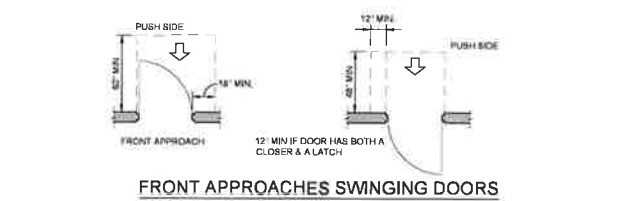

NOTE:
1. FIRE EXTINGUISHER CABINET TO BE STAINLESS STEEL SEMI-RECESSED WITH VERTICAL GLASS FIRE EXTINGUISHER AS REQUIRED BY THE FIRE CODE.
2. FIRE EXTINGUISHER CABINET TO BE ADA COMPLIANT.

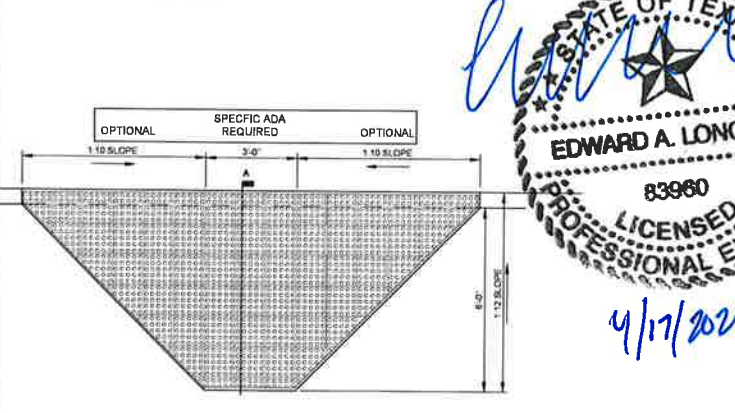
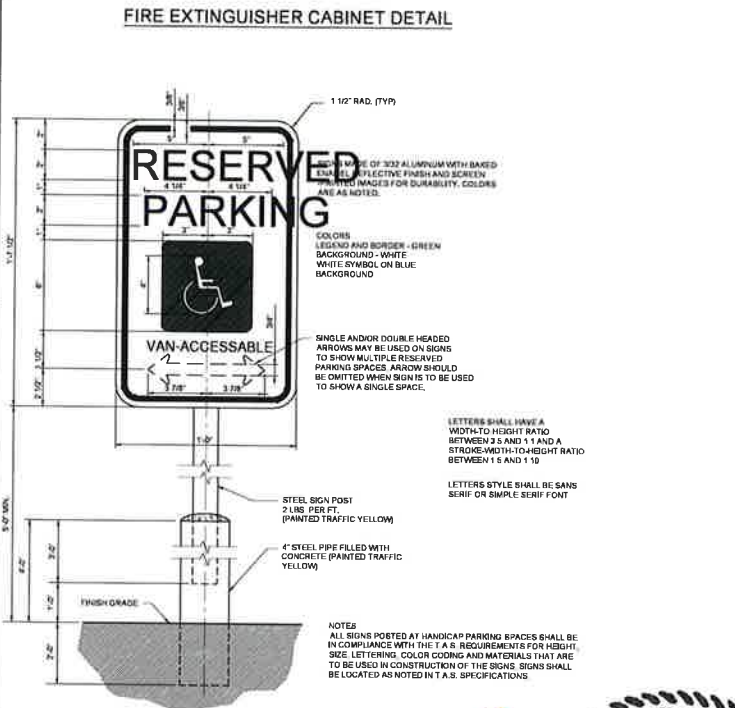

**401 HOUSTON AVE
PORT ARTHUR, TX 77642
SEAFARER PARKING LOT
EXPANSION PROJECT**

DATE: 4/15/24
SCALE: NTS
SHEET: TA5-1
SHEET #: 10 OF 10

Port of PORT ARTHUR

STATE OF TEXAS
EDWARD A. LONG, JR.
83960
LICENSED PROFESSIONAL ENGINEER
4/17/2024